

Features

- Supply Voltage: 4.5V to 36V
- Offset Voltage: $\pm 300\mu$ V Maximum
- Differential Input Voltage Range to Supply Rail, can Work as Comparator
- Input Rail to $-V_s$, Rail to Rail Output
- Bandwidth: 1 MHz
- Slew Rate: 0.7V/ μ s
- Excellent EMI Suppress Performance: 80dB at 1GHz
- Offset Voltage Temperature Drift: 2 μ V/ $^{\circ}$ C
- Low Noise: 30 nV/ $\sqrt{\text{Hz}}$ at 1kHz
- 2KV HBM, 1KV CDM
- -40° C to 125° C Operation Temperature Range

Applications

- Instrumentation
- Active Filters, ASIC Input or Output Amplifier
- Sensor Interface
- Industrial Control

Description

The TP124X series amplifiers are newest high supply voltage amplifiers with low offset, low power and stable high frequency response. They incorporate 3PEAK's proprietary and patented design techniques to achieve very good AC performance with 1MHz bandwidth, 0.7V/ μ s slew rate and low distortion while drawing only 150 μ A of quiescent current per amplifier. The input common-mode voltage range extends to V_- , and the outputs swing rail-to-rail. The TP124X family can be used as plug-in replacements for many commercially available op-amps to reduce power and improve input/output range and performance. The combination of features makes the TP124X ideal choices for industrial control, instrumentation.

Pin Configuration

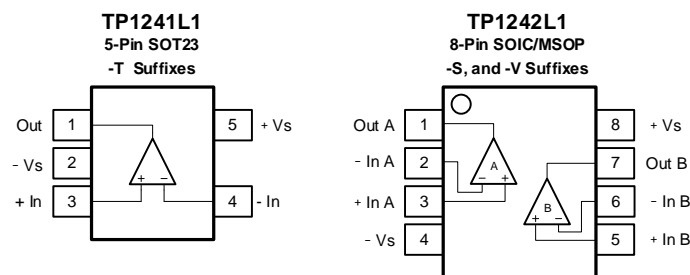

Table of Contents

Features	1
Applications	1
Description	1
Pin Configuration	1
Table of Contents	2
Revision History	3
Order Information	3
Absolute Maximum Ratings	4
ESD Rating	4
Thermal Information	4
Electrical Characteristics	5
Typical Performance Characteristics	7
Tape and Reel Information	10
Package Outline Dimensions	11
SOT23-5	11
SOIC-8	12
MSOP-8	13

Revision History

Date	Revision	Notes
2020/12/10	Rev.A.0	Initial version
2021/1/16	Rev.A.1	Updated overload recovery time: 100ns to 2us.
2021/4/15	Rev.A.2	Updated Iq of TP1241, add TP1242L1-VR.
2023/11/3	Rev.A.3	<p>The following updates are all about the new datasheet formats or typo, the actual product remains unchanged.</p> <p>Updated mark of TP1242L1-SR: "TP1242" -> "1242".</p> <p>Updated Tape and Reel Information.</p> <p>Updated Package Outline Dimensions.</p>

Order Information

Order Number	Operating Temperature Range	Package	Marking Information	MSL	Transport Media, Quantity
TP1241L1-TR	-40 to 125°C	SOT23-5	124	1	Tape and Reel, 3000
TP1242L1-SR	-40 to 125°C	SOP8	1242	1	Tape and Reel, 4000
TP1242L1-VR	-40 to 125°C	MSOP8	TP1242	1	Tape and Reel, 3000

Note 1: The sample will be ready in one month.

Absolute Maximum Ratings ^{Note 1}

Parameters	Rating
Supply Voltage, (+V _S)– (-V _S)	40 V
Input Voltage	(-V _S) – 0.3 to (+V _S) + 0.3
Differential Input Voltage	(+V _S) - (-V _S)
Input Current: +IN, –IN ^{Note 2}	±10mA
Output Short-Circuit Duration ^{Note 3}	Infinite
Maximum Junction Temperature	150°C
Operating Temperature Range	–40 to 125°C
Storage Temperature Range	–65 to 150°C
Lead Temperature (Soldering, 10 sec)	260°C

Note 1: Stresses beyond those listed under Absolute Maximum Ratings may cause permanent damage to the device. Exposure to any Absolute Maximum Rating condition for extended periods may affect device reliability and lifetime.

Note 2: The inputs are protected by ESD protection diodes to each power supply. If the input extends more than 300mV beyond the power supply, the input current should be limited to less than 10mA.

Note 3: A heat sink may be required to keep the junction temperature below the absolute maximum. This depends on the power supply voltage and how many amplifiers are shorted. Thermal resistance varies with the amount of PC board metal connected to the package. The specified values are for short traces connected to the leads.

ESD Rating

Symbol	Parameter	Condition	Minimum Level	Unit
HBM	Human Body Model ESD	ANSI/ESDA/JEDEC JS-001	2	kV
CDM	Charged Device Model ESD	ANSI/ESDA/JEDEC JS-002	1	kV

Thermal Information

Package Type	θ_{JA}	θ_{JC}	Unit
5-Pin SOT23	250	81	°C/W
8-Pin SOIC	158	43	°C/W
8-Pin MSOP	210	45	°C/W

Electrical Characteristics

All test condition is $V_S = 30V$, $T_A = 25^\circ C$, $R_L = 10k\Omega$, unless otherwise noted.

Symbol	Parameter	Conditions	T_A	Min	Typ	Max	Unit
Power Supply							
V_S	Supply Voltage Range			4.5		36	V
I_Q	Quiescent Current per Amplifier,	$V_S = 30V$, TP1241L1			250	500	μA
			-40°C to 125°C			700	μA
		$V_S = 30V$, TP1242L1			150	350	μA
			-40°C to 125°C			500	μA
PSRR	Power Supply Rejection Ratio	$V_S = 4.5V$ to 36V		100	120		dB
			-40°C to 125°C	95			dB
Input Characteristics							
V_{OS}	Input Offset Voltage	$V_S = 30V$, $V_{CM} = 15V$		-300	50	300	μV
			-40°C to 125°C	-800		800	μV
		$V_S = 5V$, $V_{CM} = 2.5V$		-300	50	300	μV
			-40°C to 125°C	-800		800	μV
		$V_S = 5V$, $V_{CM} = 0V$		-500	100	500	μV
			-40°C to 85°C	-1000		1000	μV
-40°C to 125°C	-3000		3000	μV			
$V_{OS\ TC}$	Input Offset Voltage Drift		-40°C to 125°C		2		μV/°C
I_B	Input Bias Current				25		pA
			-40°C to 85°C		80		pA
			-40°C to 125°C		1000		pA
I_{OS}	Input Offset Current				25		pA
I_{IN}	Different Input Current	$V_S = 36V$, $V_{ID} = 36V$			10	200	nA
			-40°C to 125°C			300	nA
C_{IN}	Input Capacitance	Differential Mode			5		pF
		Common Mode			2.5		pF
A_V	Open-loop Voltage Gain	$V_S = 30V$, $V_{OUT} = 0.5V$ to 29.5V		110	130		dB
			-40°C to 125°C	90			dB
V_{CMR}	Common-mode Input Voltage Range			(V-)		(V+) – 1.5	V
CMRR	Common Mode Rejection Ratio	$V_{CM} = 0.5V$ to 28.5V		100	120		dB
			-40°C to 125°C	95			dB

Output Characteristics							
V _{OH}	Output Swing from Positive Rail	R _{LOAD} = 100k Ω to V _S /2			15	30	mV
			-40°C to 125°C			50	
		R _{LOAD} = 10k Ω to V _S /2			60	90	mV
			-40°C to 125°C			140	
V _{OL}	Output Swing from Negative Rail	R _{LOAD} = 100k Ω to V _S /2			10	20	mV
			-40°C to 125°C			30	
		R _{LOAD} = 10k Ω to V _S /2			35	50	mV
			-40°C to 125°C			90	
		No Load to V-			5	10	mV
			-40°C to 125°C			15	
I _{SC}	Output Short-Circuit Current	Source			70		mA
		Sink			120		
AC Specifications							
GBW	Gain-Bandwidth Product				1		MHz
SR	Slew Rate	G = 1		0.3	0.7		V/ μ s
			-40°C to 125°C	0.1			V/ μ s
t _{OR}	Overload Recovery				2		μ s
t _S	Settling Time, 0.1%	G = -1, 10V step			15		μ s
	Settling Time, 0.01%				20		μ s
PM	Phase Margin	V _S = 36V, R _L =10K, C _L =100pF			60		°
GM	Gain Margin	V _S = 36V, R _L =10K, C _L =100pF			10		dB
Noise Performance							
E _N	Input Voltage Noise	f = 0.1Hz to 10Hz			2		μ V _{RMS}
e _N	Input Voltage Noise Density	f = 1kHz			30		nV/ \sqrt Hz
i _N	Input Current Noise	f = 1kHz			2		fA/ \sqrt Hz

Typical Performance Characteristics

$V_s = \pm 15V$, $V_{CM} = 0V$, $R_L = 10k\Omega$, unless otherwise specified.

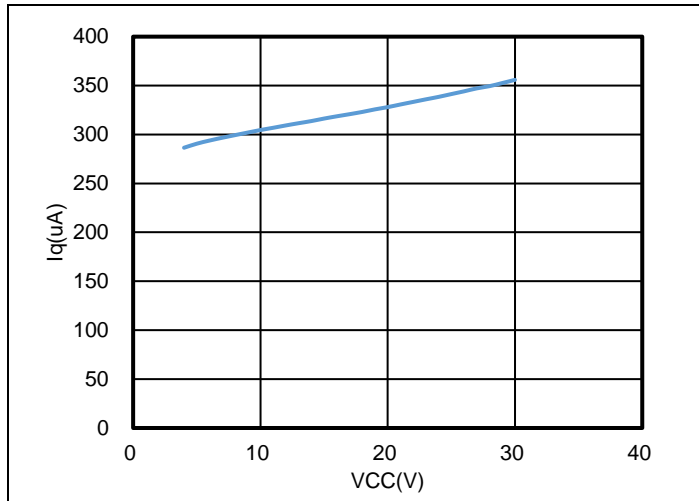

Figure 1. Iq vs. Vcc, TP1242L1

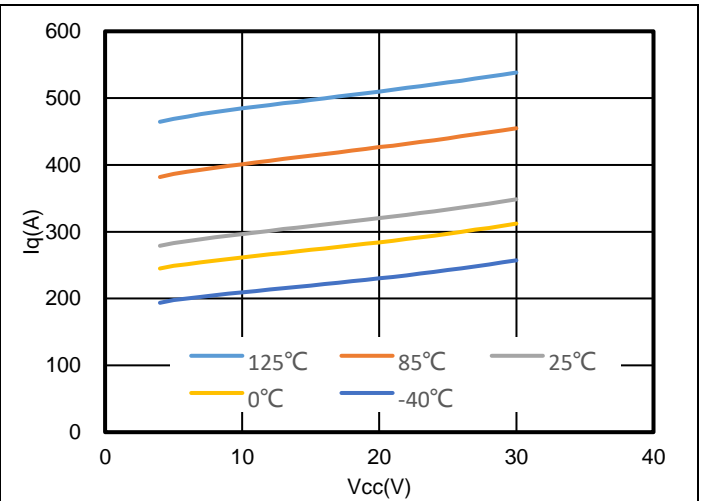

Figure 2. Iq vs. Vcc in Different Temperature, TP1242L1

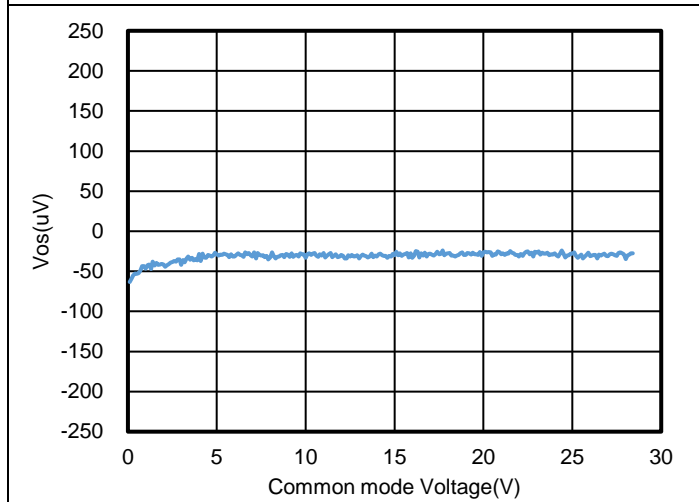

Figure 3. Offset Voltage vs. Common Mode Voltage

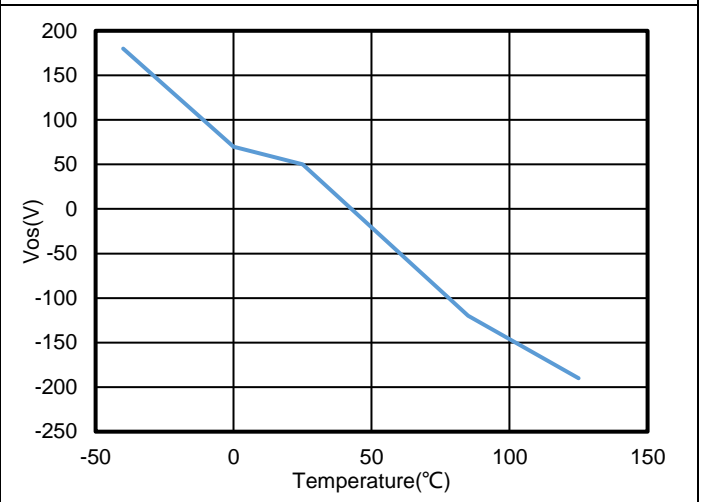

Figure 4. Vos vs. Temperature

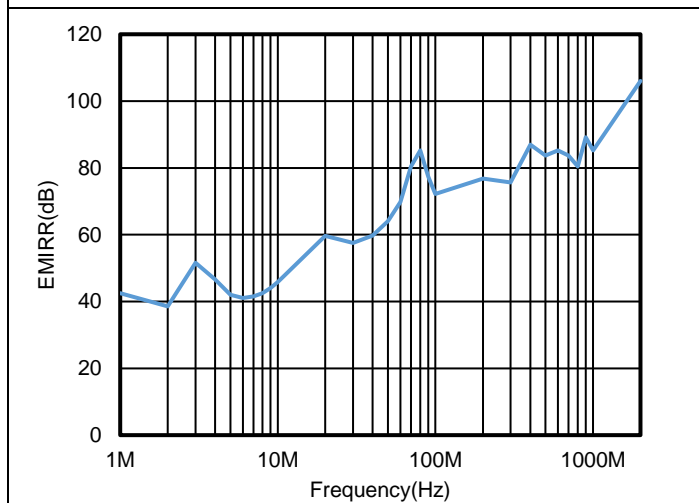

Figure 5. EMIRR vs. Frequency

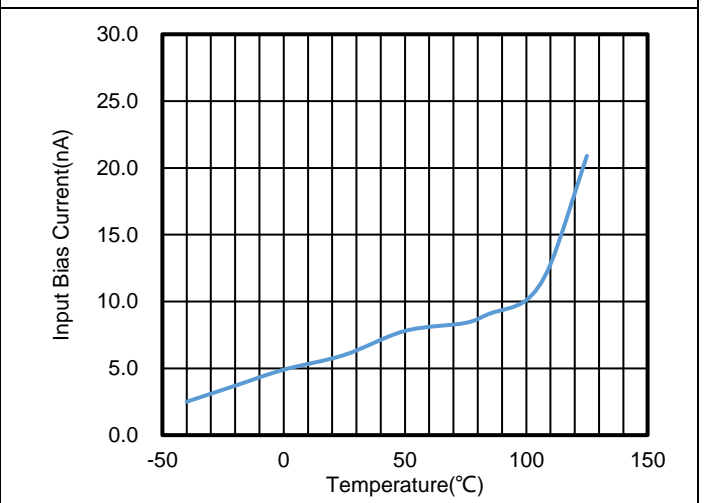

Figure 6. Input Current in Large Vdm vs. Temperature

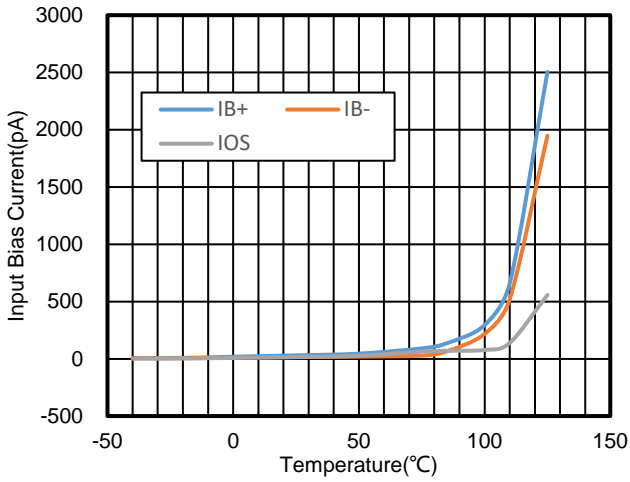

Figure 7. I_B vs. Temperature, -40 to 125°C

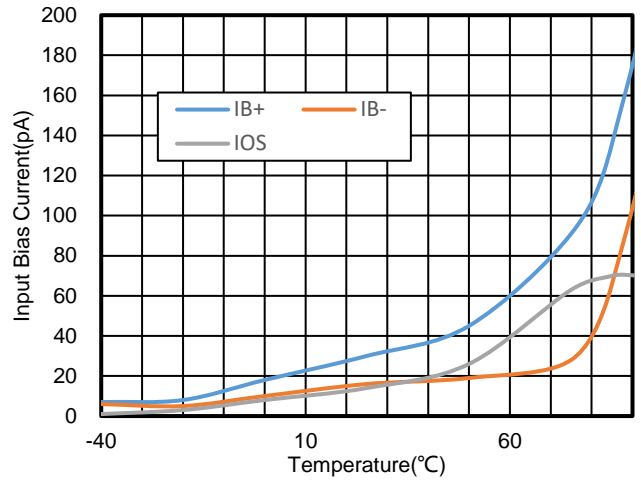

Figure 8. I_B vs. Temperature, -40 to 90°C

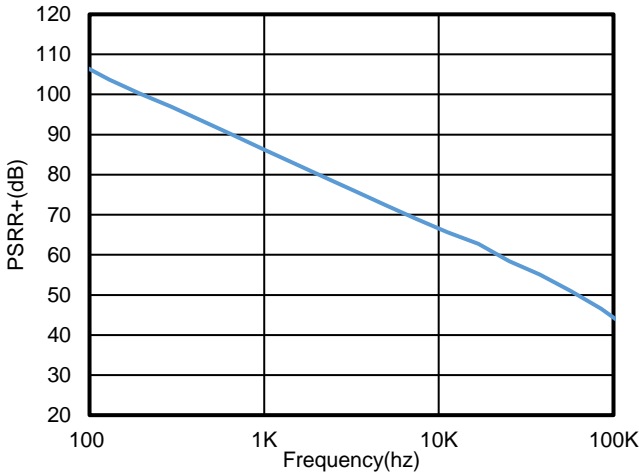

Figure 9. PSRR+ vs. Frequency

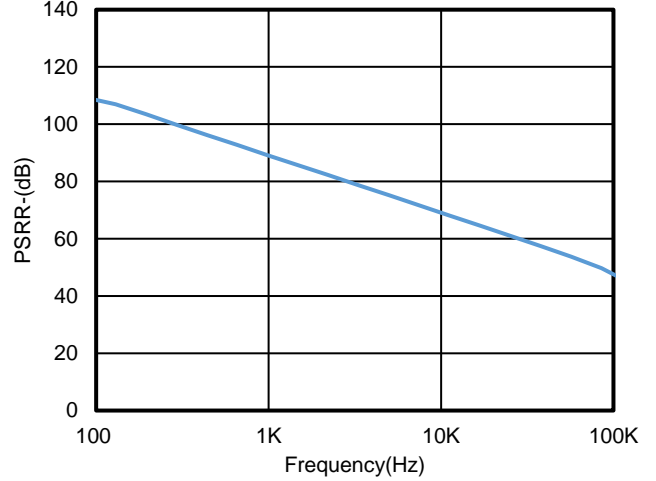

Figure 10. PSRR- vs. Frequency

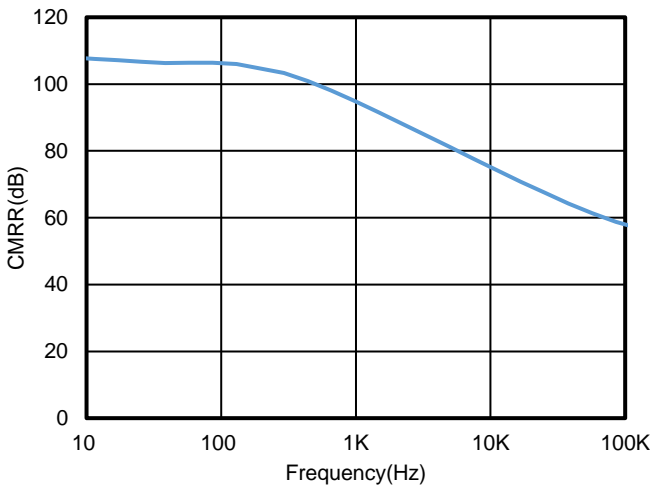

Figure 11. CMRR vs. Frequency

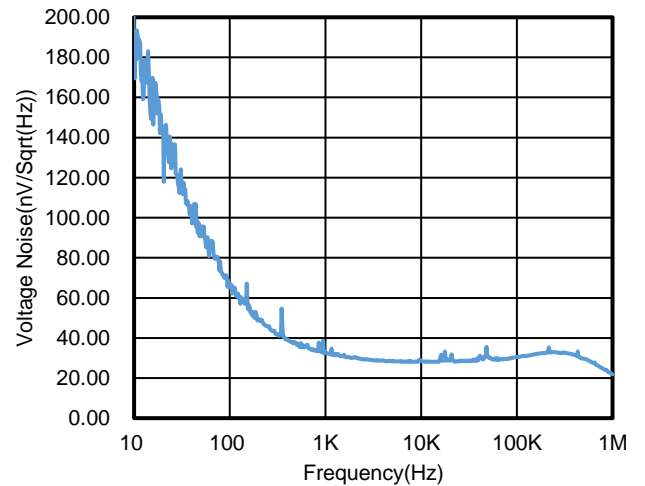

Figure 12. Voltage Noise Spectral Density vs. Frequency

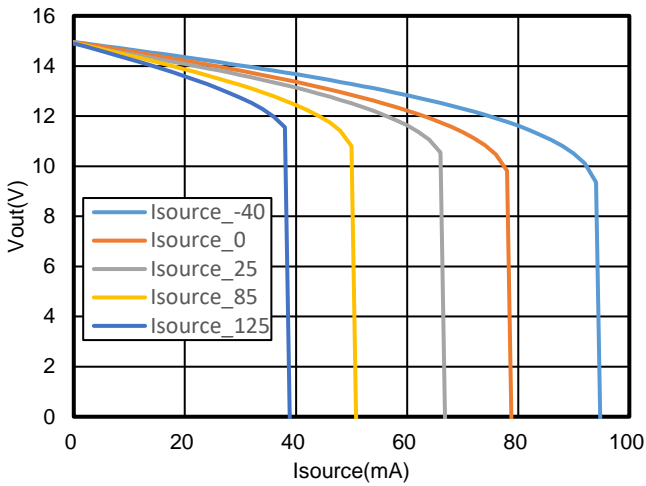

Figure 13. Positive Output Voltage vs. Output Current

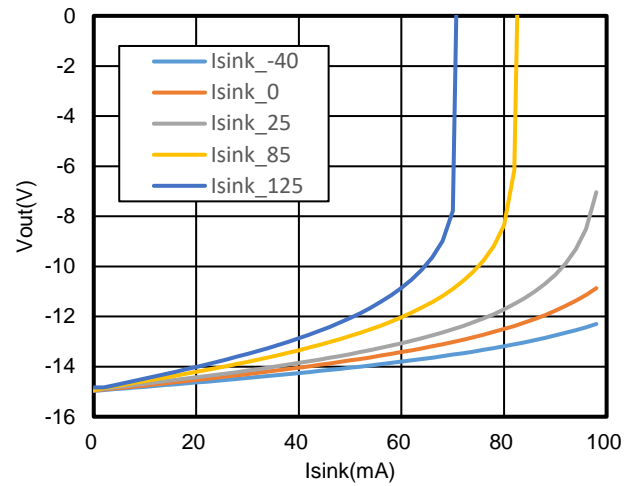

Figure 14. Negative Output Voltage vs. Output Current



Voltage: 5V/div for Output, Time: 10 μ s/div

G=10, VREF = GND; VIN=5VPP

Figure 15. Positive Overload Recovery



Voltage: 5V/div for Output, Time: 10 μ s/div

G=10, VREF = GND; VIN=5VPP

Figure 16. Negative Overload Recovery

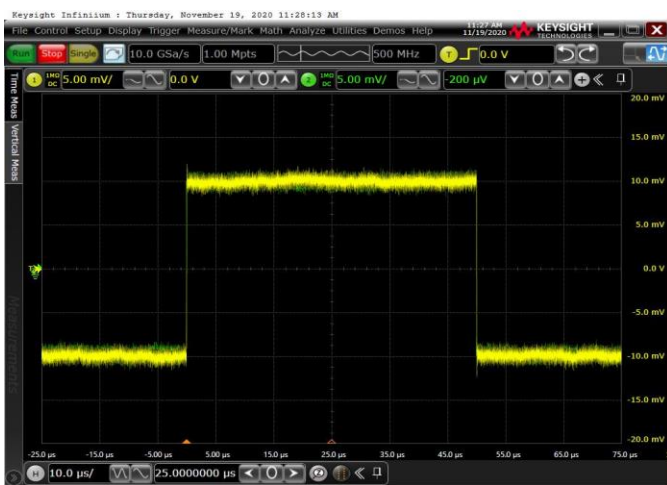

Voltage: 5mV/div, Time: 10 μ s/div

$R_L=2K$, $C_L=100pF$, G=1

Figure 17. 20mV Signal Step Response



Voltage: 5V/div, Time: 100 μ s/div

$R_L=2K$, $C_L=100pF$, G=1

Figure 18. 10V Signal Step Response

Tape and Reel Information

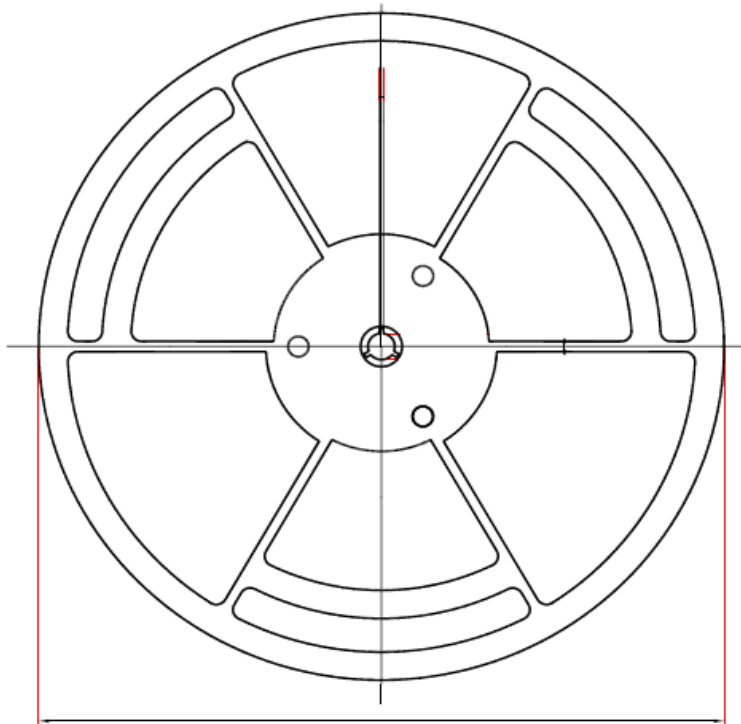

D1: Reel Diameter

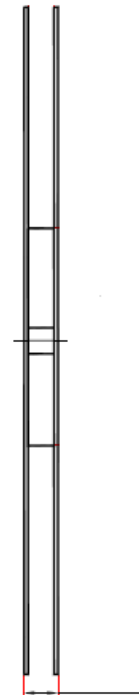

W1: Reel Width

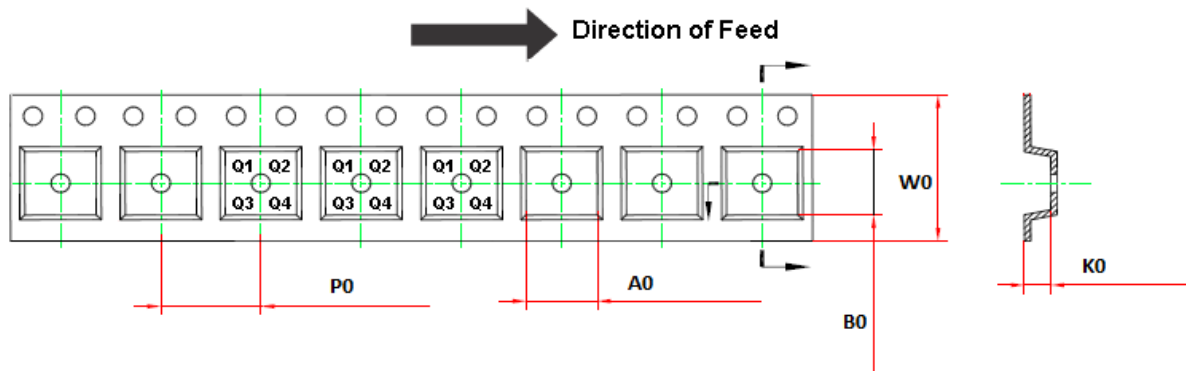

Order Number	Package	D1	W1	A0	B0	K0	P0	W0	Pin1 Quadrant
TP1241L1-TR	SOT23-5	179.0	12	3.3	3.25	1.4	4.0	8.0	Q3
TP1242L1-SR	SOP8	330.0	17.6	6.5	5.4	2.0	8.0	12.0	Q1
TP1242L1-VR	MSOP8	330.0	17.6	5.4	3.3	1.3	8.0	12.0	Q1

Package Outline Dimensions

SOT23-5

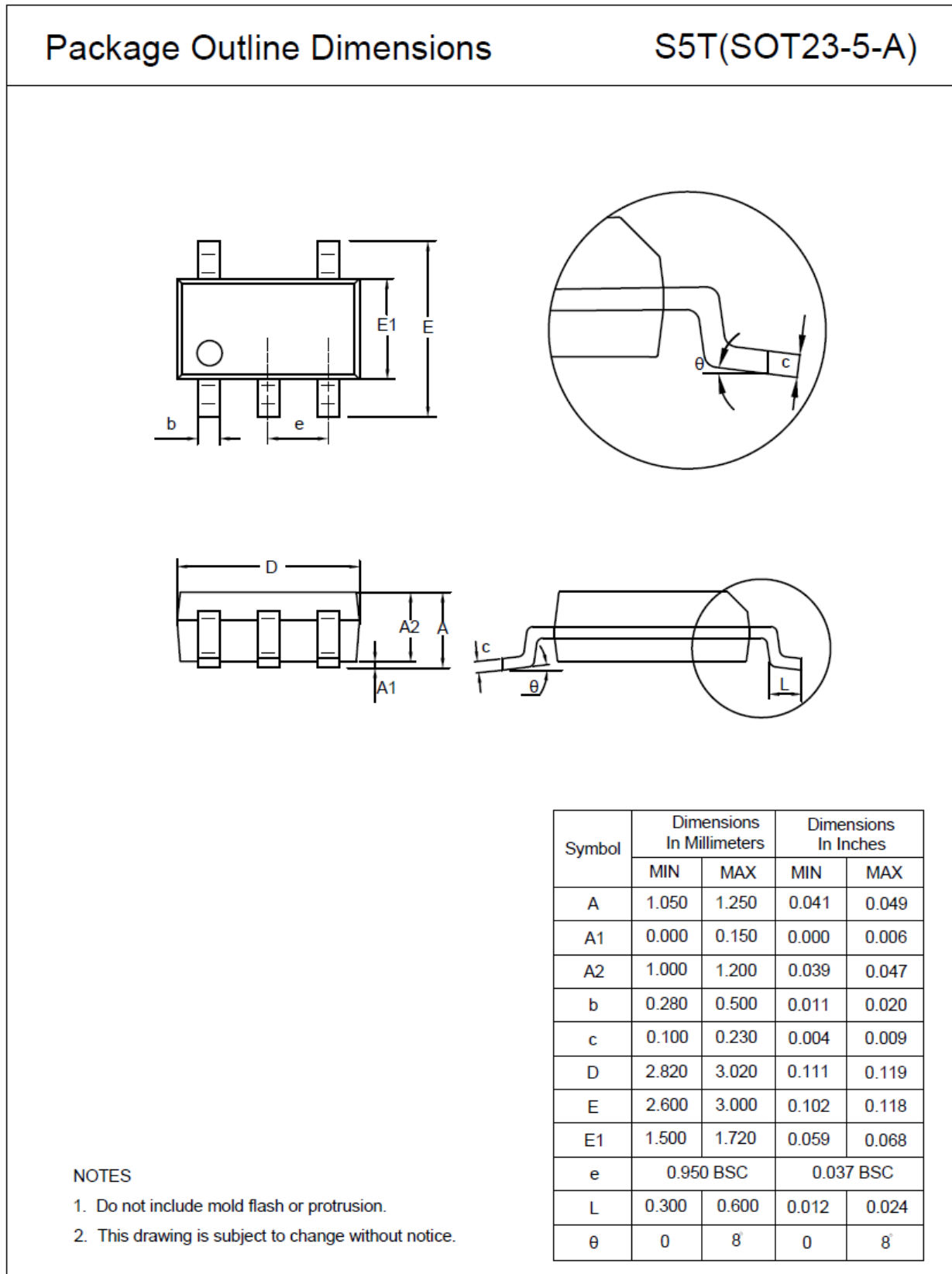

SOP8

Package Outline Dimensions

SO1(SOP-8-A)

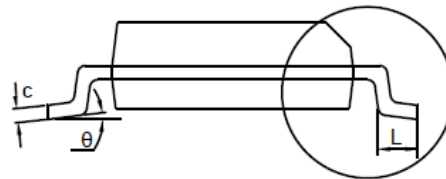
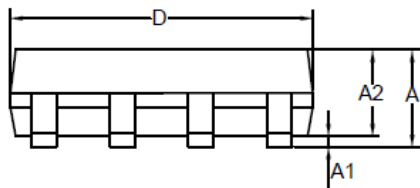
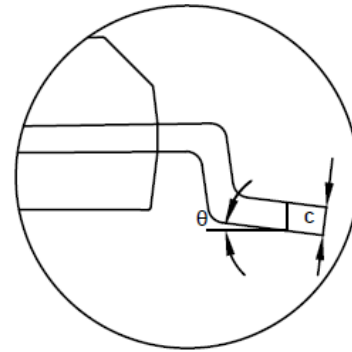
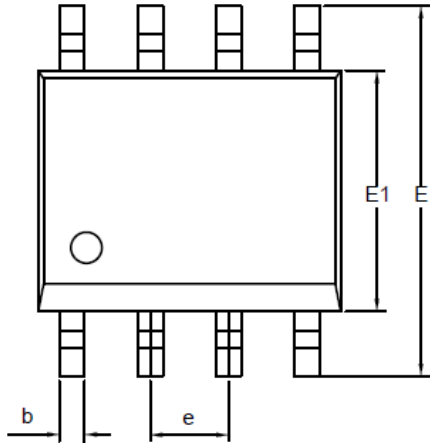

Symbol	Dimensions In Millimeters		Dimensions In Inches	
	MIN	MAX	MIN	MAX
A	1.350	1.750	0.053	0.069
A1	0.050	0.250	0.002	0.010
A2	1.250	1.550	0.049	0.061
b	0.330	0.510	0.013	0.020
c	0.170	0.250	0.007	0.010
D	4.700	5.100	0.185	0.201
E	5.800	6.200	0.228	0.244
E1	3.800	4.000	0.150	0.157
e	1.270 BSC		0.050 BSC	
L	0.400	1.000	0.016	0.039
θ	0	8°	0	8°

NOTES

1. Do not include mold flash or protrusion.
2. This drawing is subject to change without notice.

MSOP8

Package Outline Dimensions

VS1(MSOP-8-A)

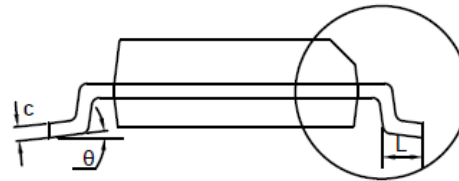
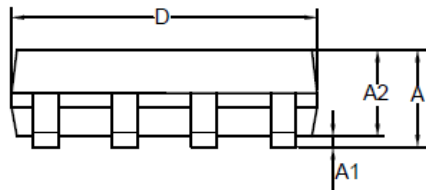
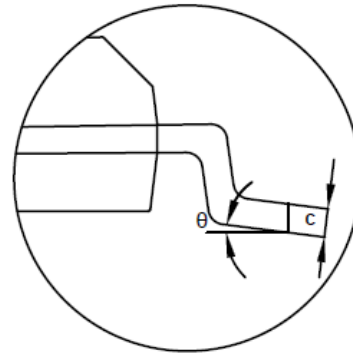
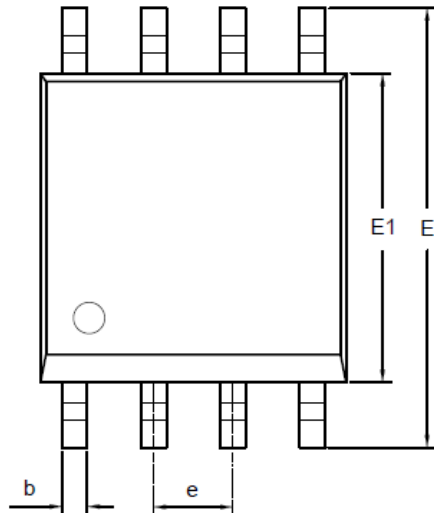

Symbol	Dimensions In Millimeters		Dimensions In Inches	
	MIN	MAX	MIN	MAX
A	0.800	1.100	0.031	0.043
A1	0.050	0.150	0.002	0.006
A2	0.750	0.950	0.030	0.037
b	0.250	0.380	0.010	0.015
c	0.090	0.230	0.004	0.009
D	2.900	3.100	0.114	0.122
E	4.700	5.100	0.185	0.201
E1	2.900	3.100	0.114	0.122
e	0.650 BSC		0.026 BSC	
L	0.400	0.800	0.016	0.031
θ	0	8°	0	8°

NOTES

1. Do not include mold flash or protrusion.
2. This drawing is subject to change without notice.

IMPORTANT NOTICE AND DISCLAIMER

Copyright© 3PEAK 2012-2023. All rights reserved.

Trademarks. Any of the 思瑞浦 or 3PEAK trade names, trademarks, graphic marks, and domain names contained in this document /material are the property of 3PEAK. You may NOT reproduce, modify, publish, transmit or distribute any Trademark without the prior written consent of 3PEAK.

Performance Information. Performance tests or performance range contained in this document/material are either results of design simulation or actual tests conducted under designated testing environment. Any variation in testing environment or simulation environment, including but not limited to testing method, testing process or testing temperature, may affect actual performance of the product.

Disclaimer. 3PEAK provides technical and reliability data (including data sheets), design resources (including reference designs), application or other design recommendations, networking tools, security information and other resources "As Is". 3PEAK makes no warranty as to the absence of defects, and makes no warranties of any kind, express or implied, including without limitation, implied warranties as to merchantability, fitness for a particular purpose or non-infringement of any third-party's intellectual property rights. Unless otherwise specified in writing, products supplied by 3PEAK are not designed to be used in any life-threatening scenarios, including critical medical applications, automotive safety-critical systems, aviation, aerospace, or any situations where failure could result in bodily harm, loss of life, or significant property damage. 3PEAK disclaims all liability for any such unauthorized use.