

Features

- Supply Voltage: 4.5V to 36V
- Offset Voltage: $\pm 50\mu\text{V}$ Maximum
- Differential Input Voltage Range to Supply Rail, can Work as Comparator
- Input Rail to $-V_s$, Rail to Rail Output
- Drive any capacitive load
- Bandwidth: 6MHz, Slew Rate: 5V/ μs
- Excellent EMI Suppress Performance: 85dB at 1GHz
- Over-Temperature Protection
- Low Noise: 8 nV/ $\sqrt{\text{Hz}}$ at 1kHz
- 2KV HBM, 1KV CDM, 500mA Latch Up
- -40°C to 125°C Operation Temperature Range

Applications

- Instrumentation
- Active Filters, ASIC Input or Output Amplifier
- Sensor Interface
- Industrial Control

Description

The TP27 is newest high supply voltage amplifiers with low offset, low power and stable high frequency response. It incorporates 3PEAK's proprietary and patented design techniques to achieve very good AC performance with 6MHz bandwidth, 5V/ μs slew rate and low distortion. The input common-mode voltage range extends to V_- , and the outputs swing rail-to-rail. The TP27 family can be used as plug-in replacements for many commercially available op-amps to reduce power and improve input/output range and performance.

The combination of features makes the TP27 ideal choices for industrial control, instrumentation.

	TP07A	TP17	TP27
Vos 25°C, μV	± 150	± 100	± 50
Vos -40 to 85°C, μV	± 500	± 400	± 70
GBW, MHz	1	6	6
Iq, mA	1.5	2	1.6

Pin Configuration

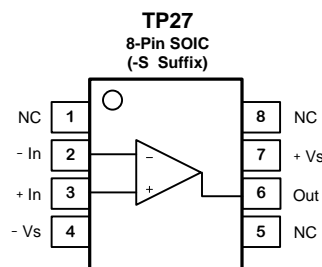

Table of Contents

Features	1
Applications	1
Description	1
Pin Configuration	1
Table of Contents	2
Revision History	3
Order Information	3
Absolute Maximum Ratings ^{Note 1}	4
ESD Rating	4
Thermal Information	4
Electrical Characteristics	5
Typical Performance Characteristics	7
Tape and Reel Information	10
Package Outline Dimensions	11
SOIC-8	11
IMPORTANT NOTICE AND DISCLAIMER	12

Revision History

Date	Revision	Notes
2018/12/21	Rev.Pre	Pre-Release Version
2019/9/11	Rev.0	Initial Version
2020/8/1	Rev.A	Correct typo in the header: 5MHz -> 6MHz, Add Test Figure
2021/7/7	Rev.A.1	Update maximum rating: Input voltage: $(-V_s) - 0.3$ to $(+V_s) + 0.3$ -> $(-V_s) - 0.3$ to 40 V Differential Input Voltage : $(+V_s) - (-V_s)$ -> $(-V_s) - (+V_s)$ to $(+V_s) - (-V_s)$

Order Information

Order Number	Operating Temperature Range	Package	Marking Information	MSL	Transport Media, Quantity
TP27-SR	-40 to 125°C	8-Pin SOIC	TP27	3	Tape and Reel, 4000

Absolute Maximum Ratings ^{Note 1}

Parameters	Rating
Supply Voltage, (+V _S)– (-V _S)	40 V
Input Voltage	(-V _S) – 0.3 to 40 V
Differential Input Voltage	(-V _S) - (+V _S) to (+V _S) - (-V _S)
Input Current: +IN, –IN ^{Note 2}	±10mA
Output Voltage	(-V _S) – 0.3 to (+V _S) + 0.3
Output Short-Circuit Duration ^{Note 3}	Infinite
Maximum Junction Temperature	150°C
Operating Temperature Range	–40 to 125°C
Storage Temperature Range	–65 to 150°C
Lead Temperature (Soldering, 10 sec)	260°C

Note 1: Stresses beyond those listed under Absolute Maximum Ratings may cause permanent damage to the device. Exposure to any Absolute Maximum Rating condition for extended periods may affect device reliability and lifetime.

Note 2: The inputs are protected by ESD protection diodes to negative power supply. If the input extends more than 300mV beyond the negative power supply, the input current should be limited to less than 10mA.

Note 3: A heat sink may be required to keep the junction temperature below the absolute maximum. This depends on the power supply voltage and how many amplifiers are shorted. Thermal resistance varies with the amount of PC board metal connected to the package. The specified values are for short traces connected to the leads.

ESD Rating

Symbol	Parameter	Condition	Minimum Level	Unit
HBM	Human Body Model ESD	ANSI/ESDA/JEDEC JS-001	2	kV
CDM	Charged Device Model ESD	ANSI/ESDA/JEDEC JS-002	1	kV
LU	Latch Up	JESD 78, 25°C	500	mA
		JESD 78, 125°C	250	mA

Thermal Information

Package Type	θ_{JA}	θ_{JC}	Unit
8-Pin SOIC	158	43	°C/W

Electrical Characteristics

All test condition is $V_S = 30V$, $T_A = 25^\circ C$, $R_L = 10k\Omega$, unless otherwise noted.

Symbol	Parameter	Conditions	T_A	Min	Typ	Max	Unit
Power Supply							
V_S	Supply Voltage Range			4.5		36	V
I_Q	Quiescent Current per Amplifier	$V_S = 30V$			1.4	1.6	mA
			$-40^\circ C$ to $125^\circ C$			1.8	mA
		$V_S = 5V$			1.2	1.5	mA
			$-40^\circ C$ to $125^\circ C$			1.7	mA
PSRR	Power Supply Rejection Ratio	$V_S = 4.5V$ to $36V$		125	140		dB
			$-40^\circ C$ to $125^\circ C$	120			dB
Input Characteristics							
V_{OS}	Input Offset Voltage	$V_S = 30V$, $V_{CM} = 15V$		-50		50	μV
			$-40^\circ C$ to $125^\circ C$	-70		70	μV
		$V_S = 5V$, $V_{CM} = 2.5V$		-50		50	μV
			$-40^\circ C$ to $125^\circ C$	-70		70	μV
$V_{OS\ TC}$	Input Offset Voltage Drift		$-40^\circ C$ to $125^\circ C$		0.01	0.2	$\mu V/^\circ C$
I_B	Input Bias Current				100		pA
		$-40^\circ C$ to $125^\circ C$			100		pA
I_{OS}	Input Offset Current				100		pA
I_{IN}	Differential Input Current	$V_S = 36V$, $V_{ID} = 36V$			10	100	μA
			$-40^\circ C$ to $125^\circ C$			120	μA
C_{IN}	Input Capacitance	Differential Mode			5		pF
		Common Mode			2.5		pF
A_v	Open-loop Voltage Gain	$R_{LOAD} = 10k\Omega$, $V_{OUT} = 0.5V$ to $29.5V$		130	140		dB
			$-40^\circ C$ to $125^\circ C$	125			dB
V_{CMR}	Common-mode Input Voltage Range			(V-)		(V+) – 1.5	V
CMRR	Common Mode Rejection Ratio	$V_{CM} = 0V$ to $28.5V$		125	140		dB
			$-40^\circ C$ to $125^\circ C$	120			dB

Output Characteristics							
	Output Swing from Positive Rail	$R_{LOAD} = 100k\Omega$ to $V_{S/2}$			10	15	mV
			-40°C to 125°C			30	
		$R_{LOAD} = 10k\Omega$ to $V_{S/2}$			75	100	mV
			-40°C to 125°C			180	mV
		$R_{LOAD} = 2k\Omega$ to $V_{S/2}$			400	500	mV
			-40°C to 125°C			750	mV
	Output Swing from Negative Rail	$R_{LOAD} = 100k\Omega$ to $V_{S/2}$			3	5	mV
			-40°C to 125°C			10	mV
		$R_{LOAD} = 10k\Omega$ to $V_{S/2}$			25	35	mV
			-40°C to 125°C			60	mV
		$R_{LOAD} = 2k\Omega$ to $V_{S/2}$			130	150	mV
			-40°C to 125°C			300	mV
I_{SC}	Output Short-Circuit Current	Source		60	95		mA
			-40°C to 85°C	40			mA
			-40°C to 125°C	35			mA
		Sink		130	150		mA
			-40°C to 85°C	100			mA
			-40°C to 125°C	85			mA
	Capacitive Load Drive				1		nF
AC Specifications							
GBW	Gain-Bandwidth Product				6		MHz
SR	Slew Rate	$G = 1, 10V$ step		3	5		V/ μ s
			-40°C to 125°C	2.2			V/ μ s
t_{OR}	Overload Recovery				500		ns
t_S	Settling Time, 0.1%	$G = 1, 10V$ step			7		μ s
	Settling Time, 0.01%				12		μ s
PM	Phase Margin	$R_L=10K, C_L=100pF$			70		°
GM	Gain Margin	$R_L=10K, C_L=100pF$			15		dB
Noise Performance							
E_N	Input Voltage Noise	$f = 0.1Hz$ to $10Hz$			0.1		μ V _{PP}
e_N	Input Voltage Noise Density	$f = 0.1Hz$			8		nV/ \sqrt{Hz}
		$f = 1kHz$			8		nV/ \sqrt{Hz}
		$f = 10kHz$			10		nV/ \sqrt{Hz}
		$f = 100kHz$			20		nV/ \sqrt{Hz}
i_N	Input Current Noise	$f = 10kHz$			200		fA/ \sqrt{Hz}
THD+N	Total Harmonic Distortion and Noise	$f = 1kHz, G = 1, R_L = 10k\Omega, V_{OUT} = 6V_{RMS}$			0.0005		%

Typical Performance Characteristics

V_s = ±15V, V_{CM} = 0V, R_L = 10kΩ, unless otherwise specified.

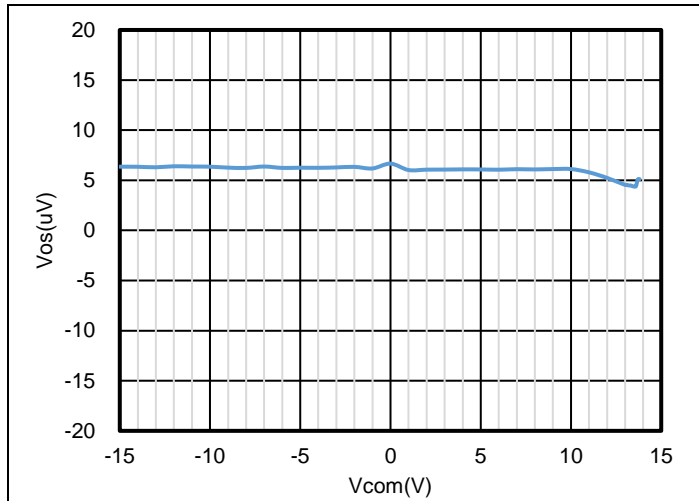

Figure 1. Offset Voltage vs. Common Mode Voltage

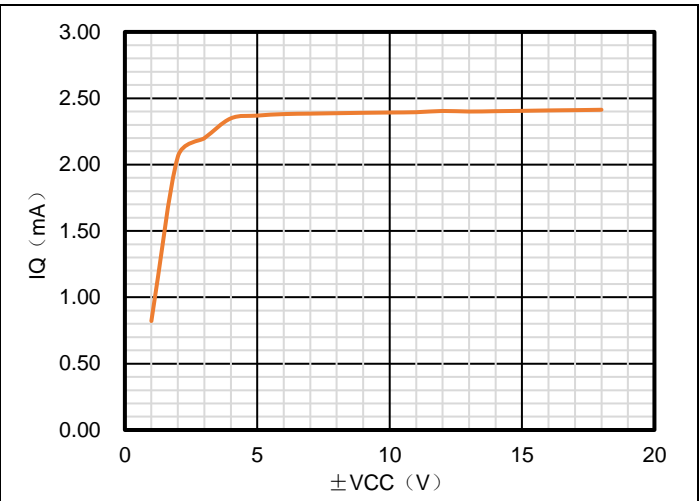

Figure 2. Iq vs. Supply Voltage

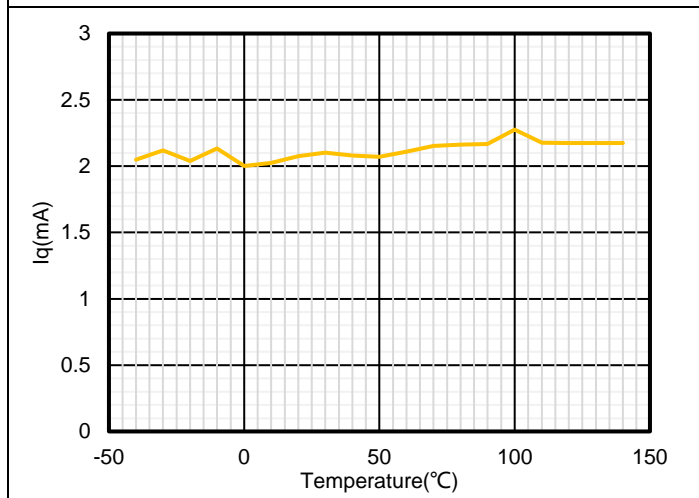

Figure 3. Iq vs. Temperature, +2.5V Supply

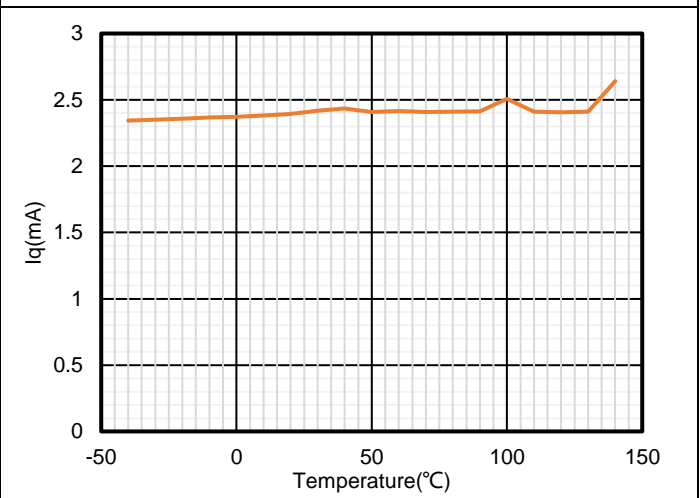

Figure 4. Iq vs. Temperature, ±15V Supply

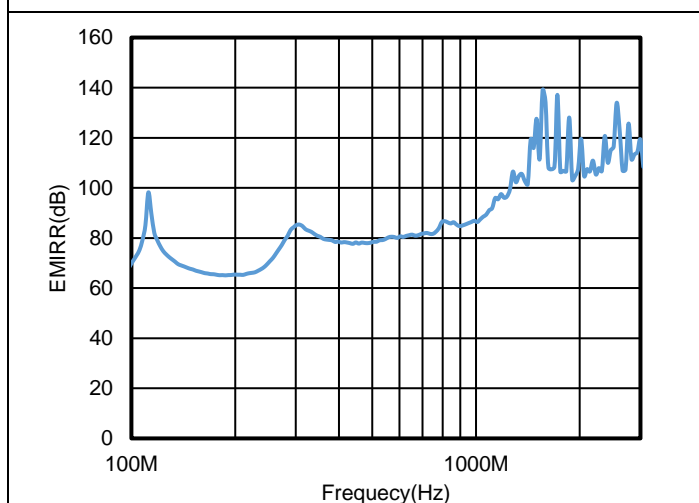

Figure 5. EMIRR vs. Frequency

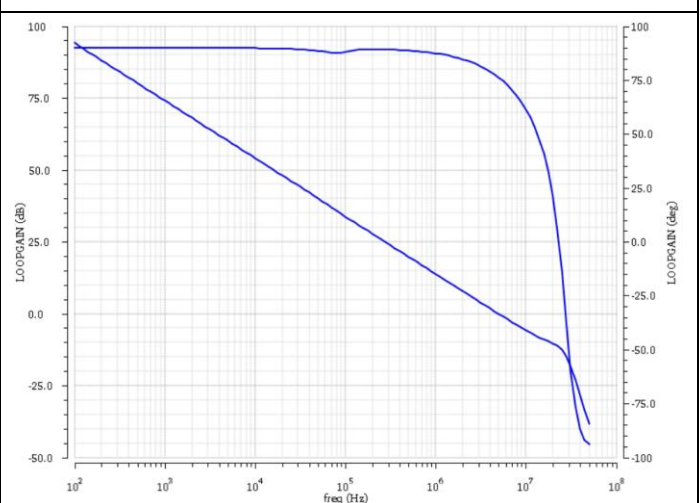

Figure 6. Open Loop Gain and Phase vs. Frequency

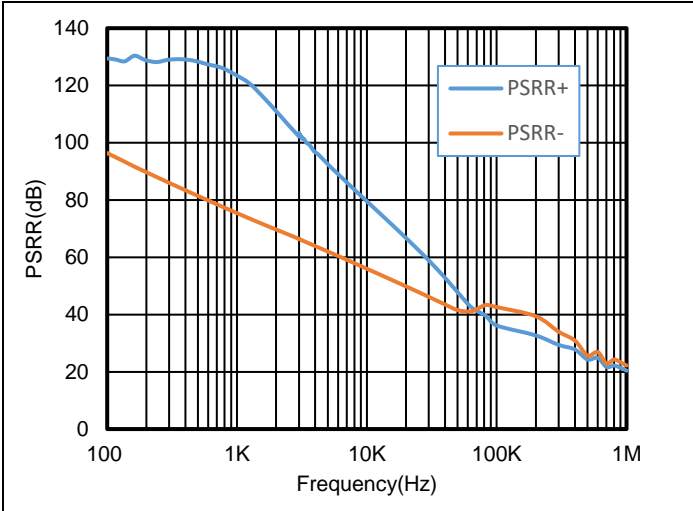

Figure 7. PSRR vs. Frequency

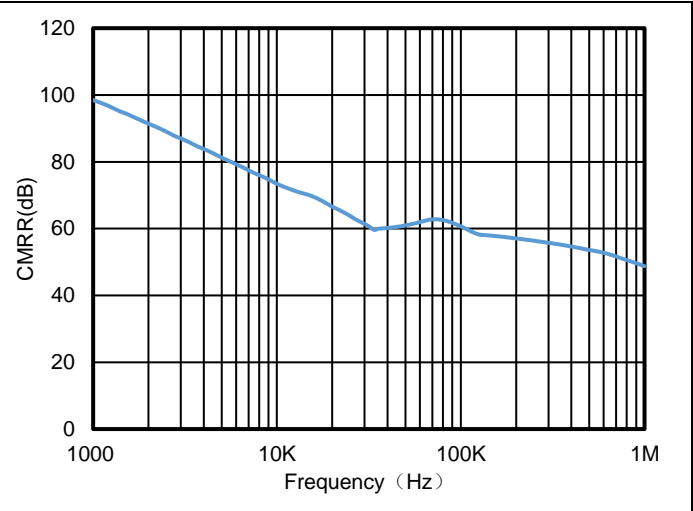
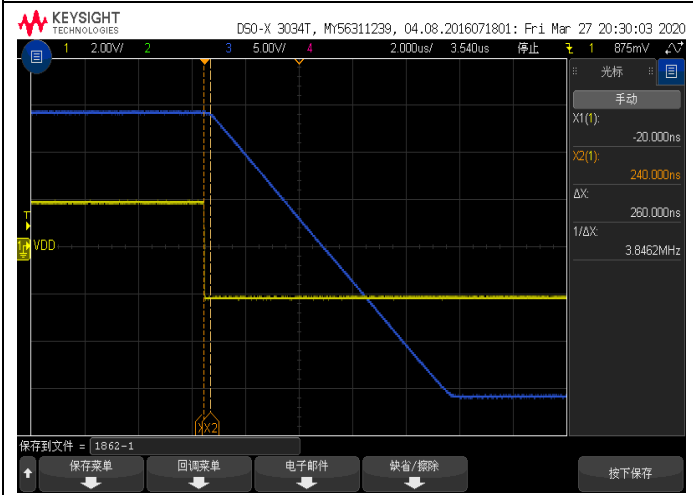
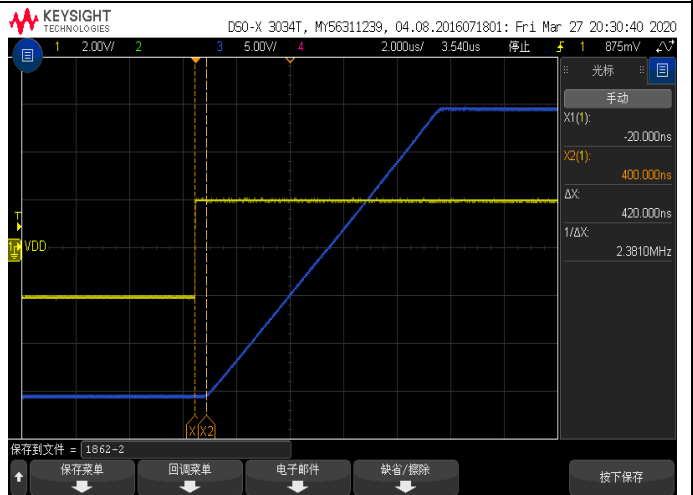

Figure 8. CMRR vs. Frequency



Time: 2us/div, Measure Time: 260ns
RL=2K, CL=100pF, G=10
Figure 9. Positive Overload Recovery



Time: 2us/div, Measure Time: 420ns
RL=2K, CL=100pF, G=10
Figure 10. Negative Overload Recovery

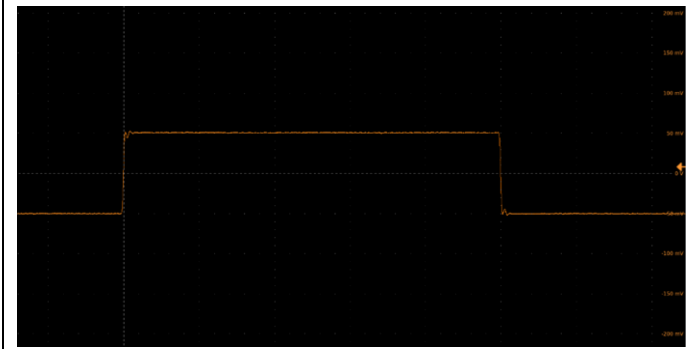

Voltage: 50mV/div, Time: 2us/div
RL=2K, CL=100pF, G=1
Figure 11. 100mV Signal Step Response

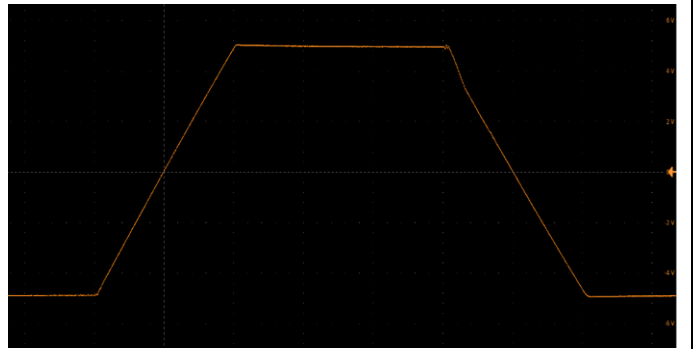

Voltage: 2V/div, Time: 2μs/div
RL=2K, CL=100pF, G=1
Figure 12. 10V Signal Step Response

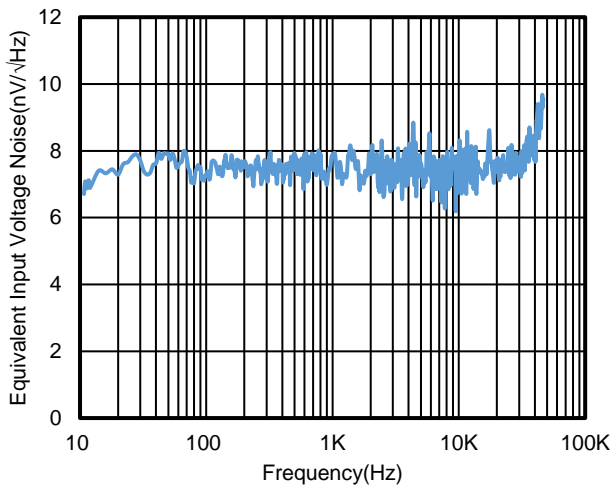

Figure 13. Voltage Noise Density vs. Frequency

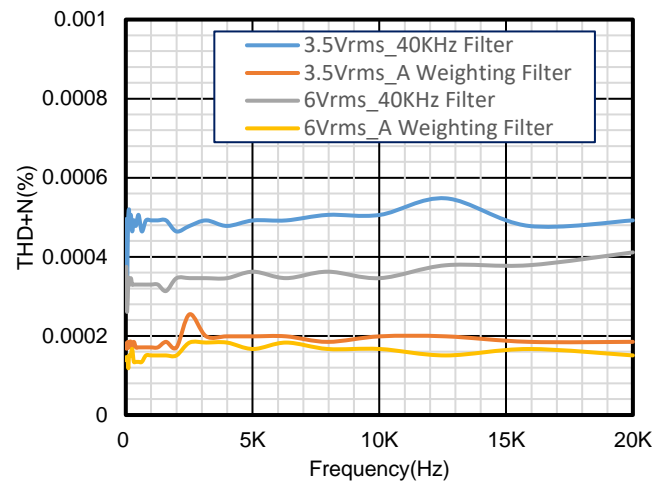

Figure 14. THD vs. Frequency, G = 1

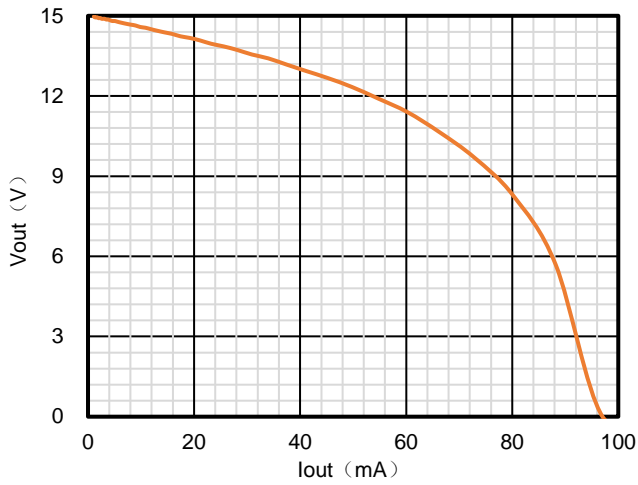

Figure 15. V_{OUT} vs. I_{OUT}, Source

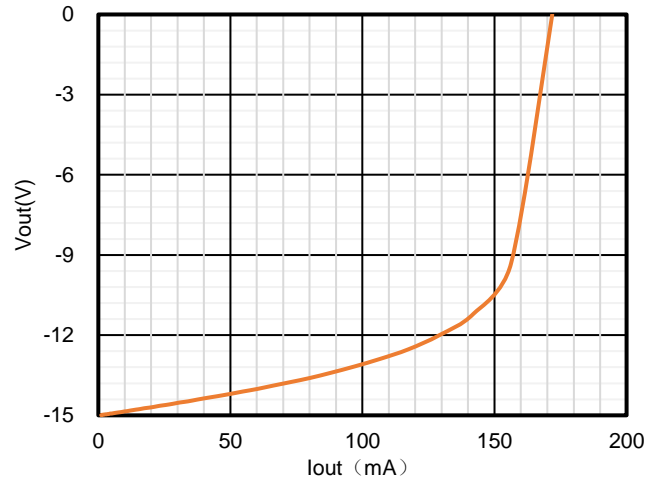
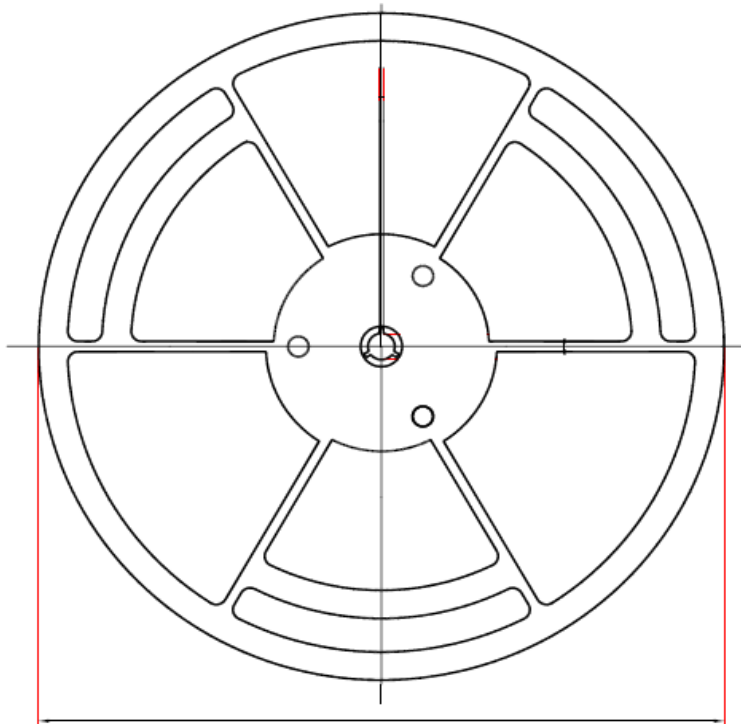
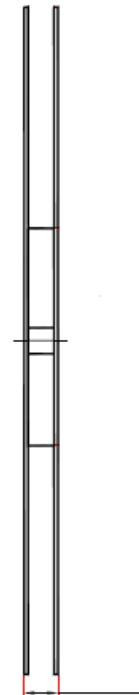

Figure 16. V_{OUT} vs. I_{OUT}, Sink

Tape and Reel Information



D1: Reel Diameter



W1: Reel Width

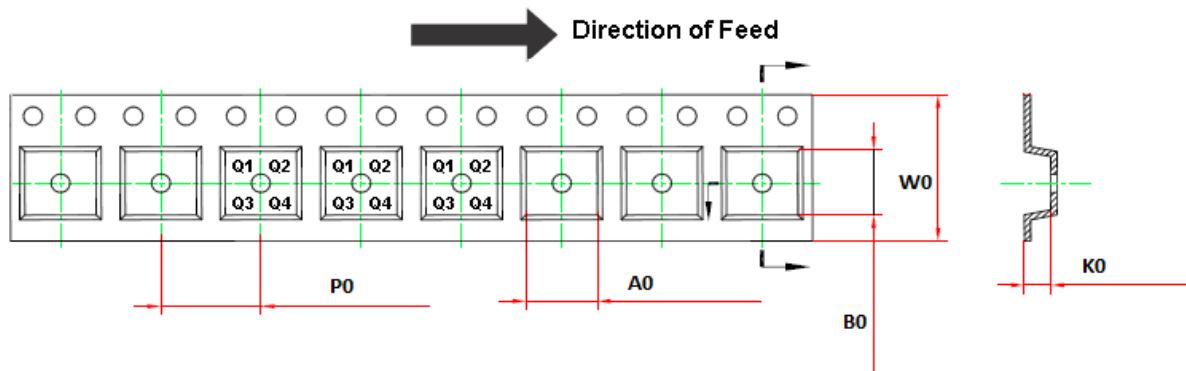

Order Number	Package	D1	W1	A0	B0	K0	P0	W0	Pin1 Quadrant
TP27-SR	8-Pin SOIC	330.0	17.6	6.4	5.4	2.1	8.0	12.0	Q1

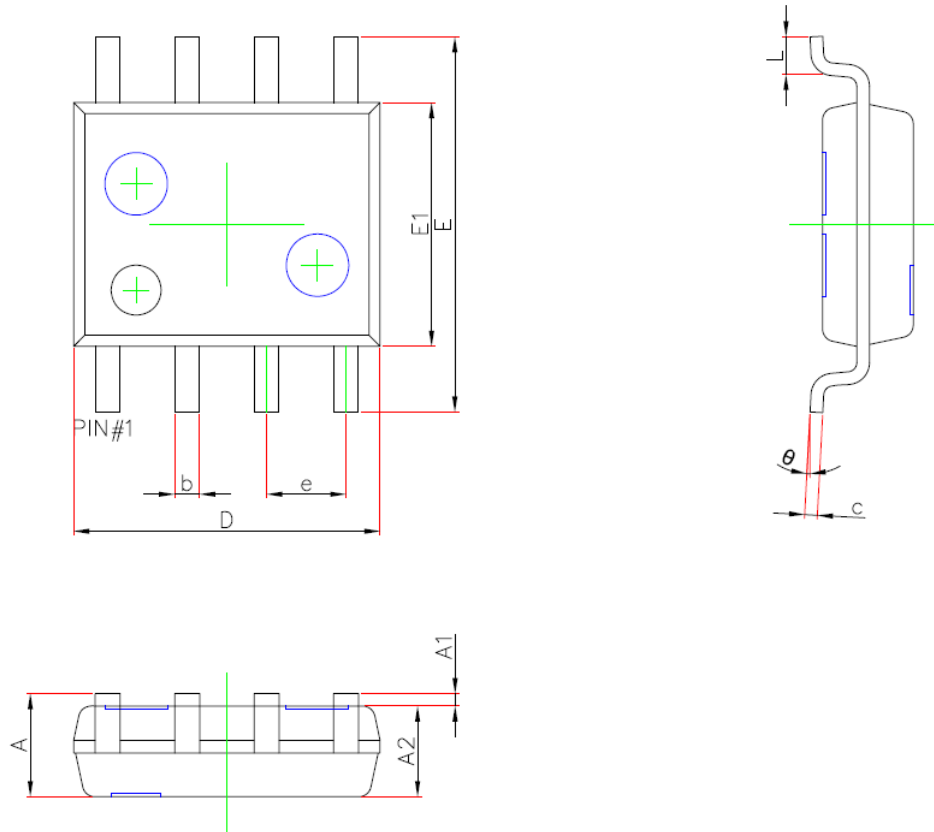
Package Outline Dimensions
SOIC-8

Symbol	Dimensions In Millimeters		Dimensions In Inches	
	Min.	Max.	Min.	Max.
A	1.350	1.750	0.053	0.069
A1	0.100	0.250	0.004	0.010
A2	1.350	1.550	0.053	0.061
b	0.330	0.510	0.013	0.020
c	0.170	0.250	0.007	0.010
D	4.700	5.100	0.185	0.201
E	5.800	6.200	0.228	0.244
E1	3.800	4.000	0.150	0.157
e	1.270(BSC)		0.050(BSC)	
L	0.400	0.800	0.016	0.031
θ	0°	8°	0°	8°

IMPORTANT NOTICE AND DISCLAIMER

Copyright© 3PEAK 2012-2023. All rights reserved.

Trademarks. Any of the 思瑞浦 or 3PEAK trade names, trademarks, graphic marks, and domain names contained in this document /material are the property of 3PEAK. You may NOT reproduce, modify, publish, transmit or distribute any Trademark without the prior written consent of 3PEAK.

Performance Information. Performance tests or performance range contained in this document/material are either results of design simulation or actual tests conducted under designated testing environment. Any variation in testing environment or simulation environment, including but not limited to testing method, testing process or testing temperature, may affect actual performance of the product.

Disclaimer. 3PEAK provides technical and reliability data (including data sheets), design resources (including reference designs), application or other design recommendations, networking tools, security information and other resources "As Is". 3PEAK makes no warranty as to the absence of defects, and makes no warranties of any kind, express or implied, including without limitation, implied warranties as to merchantability, fitness for a particular purpose or non-infringement of any third-party's intellectual property rights. Unless otherwise specified in writing, products supplied by 3PEAK are not designed to be used in any life-threatening scenarios, including critical medical applications, automotive safety-critical systems, aviation, aerospace, or any situations where failure could result in bodily harm, loss of life, or significant property damage. 3PEAK disclaims all liability for any such unauthorized use.