

Features

- Supply Voltage: 2.7 V to 5.5 V
- Offset Voltage: $\pm 20 \mu\text{V}$ Maximum within Temperature Range from -40°C to 125°C
- Offset Voltage Drift: $0.01 \mu\text{V}/^\circ\text{C}$
- Rail-to-Rail Input and Output
- Bandwidth: 3.5 MHz
- Slew Rate: $4.7 \text{ V}/\mu\text{s}$
- Low Noise: $12 \text{ nV}/\sqrt{\text{Hz}}$ at 1 kHz

Applications

- On-Board Charger
- Motor Control
- Current Measurement

Description

The TPA5561 and TPA5562 devices are single and dual operational amplifiers. The devices have very low offset voltage within the operating temperature range by the zero-drift technology. The offset voltage of the device is $\pm 20 \mu\text{V}$ maximum within the temperature range from -40°C to 125°C .

The TPA5561 and TPA5562 devices provide rail-to-rail input and output. The devices have excellent AC performance with 3.5-MHz bandwidth, $4.7\text{-V}/\mu\text{s}$ slew rate while drawing 0.5-mA quiescent current per amplifier.

The devices can be used in high-accuracy and high-speed signal conditions.

Typical Application Circuit

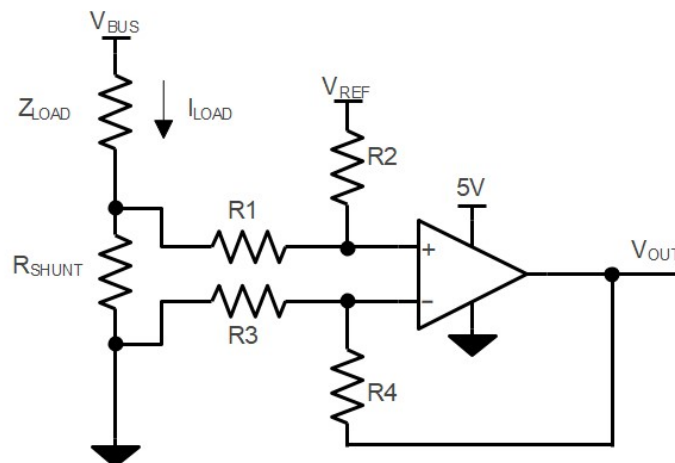

$$V_{\text{OUT}} = (I_{\text{LOAD}} \times R_{\text{SHUNT}}) \times (R_2 / R_1) + V_{\text{REF}}$$

$$\text{When } R_3 = R_1, R_2 = R_4, R_{\text{SHUNT}} \ll R_1$$

Table of Contents

Features	1
Applications	1
Description	1
Typical Application Circuit	1
Revision History	3
Pin Configuration and Functions	4
Specifications	6
Absolute Maximum Ratings ⁽¹⁾	6
ESD, Electrostatic Discharge Protection.....	6
Recommended Operating Conditions.....	6
Thermal Information.....	6
Electrical Characteristics.....	8
Typical Performance Characteristics.....	10
Detailed Description	14
Overview.....	14
Functional Block Diagram.....	14
Feature Description.....	14
Application and Implementation	16
Application Information	16
Tape and Reel Information	17
Package Outline Dimensions	19
SOT23-5.....	19
SOT353.....	20
TSSOP8.....	21
MSOP8.....	22
SOP8.....	23
Order Information	24
IMPORTANT NOTICE AND DISCLAIMER	25

Revision History

Date	Revision	Notes
2023-01-03	Rev.A.0	Initial version.

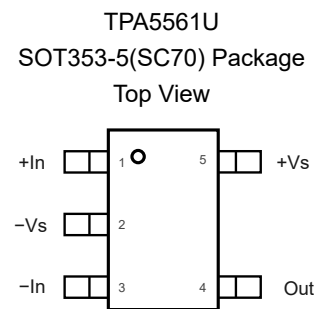
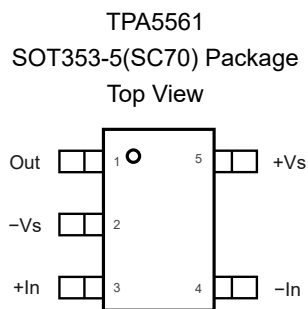
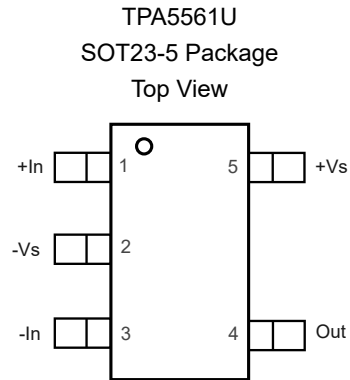
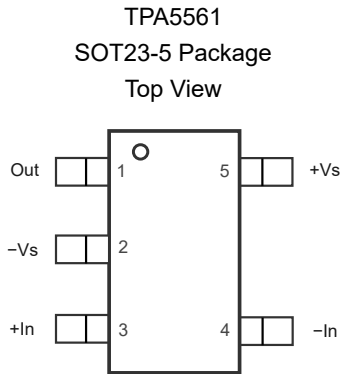
Pin Configuration and Functions

Table 1. Pin Functions: TPA5561, TPA5561U

Pin No.		Name	I/O	Description
TPA5561	TPA5561U			
1	4	Out	O	Output
2	2	-Vs	-	Negative power supply
3	1	+In	I	Noninverting input
4	3	-In	I	Inverting input
5	5	+Vs	-	Positive power supply

TPA5562

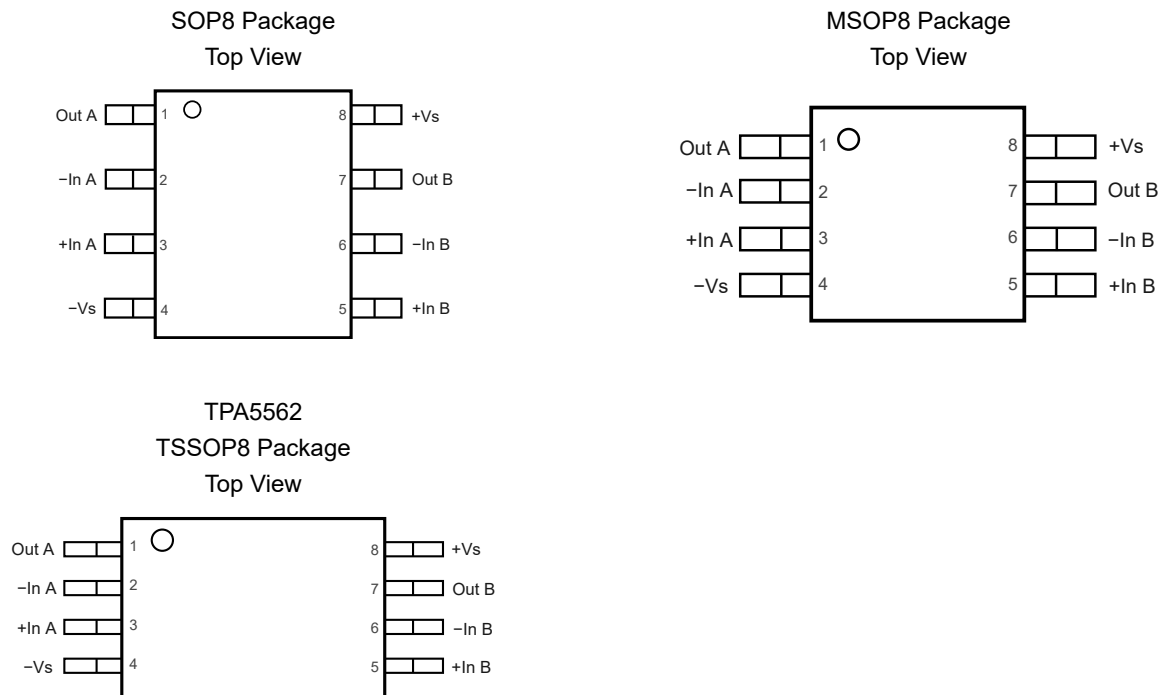
TPA5562

5-V, Zero-Drift Operational Amplifiers

Table 2. Pin Functions: TPA5562

Pin No.	Name	I/O	Description
1	Out A	O	Output
2	-In A	I	Inverting input
3	+In A	I	Noninverting input
4	-Vs	-	Negative power supply
5	+In B	I	Noninverting input
6	-In B	I	Inverting input
7	Out B	O	Output
8	+Vs		Positive power supply

Specifications

Absolute Maximum Ratings ⁽¹⁾

Parameter		Min	Max	Unit
	Supply Voltage, (+V _S) – (–V _S)		6.5	V
	Input Voltage	(–V _S) – 0.3	(+V _S) + 0.3	V
	Differential Input Voltage	(–V _S) – (+V _S)	(+V _S) – (–V _S)	V
	Input Current: +I _N , –I _N ⁽²⁾	–10	+10	mA
	Output Short-Circuit Duration ⁽³⁾		Infinite	
T _J	Maximum Junction Temperature		150	°C
T _A	Operating Temperature Range	–40	125	°C
T _{STG}	Storage Temperature Range	–65	150	°C
T _L	Lead Temperature (Soldering 10 sec)		260	°C

(1) Stresses beyond those listed under Absolute Maximum Ratings may cause permanent damage to the device. Exposure to any Absolute Maximum Rating condition for extended periods may affect device reliability and lifetime.

(2) The inputs are protected by ESD protection diodes to power supply. If the input extends more than 300 mV beyond the power supply, the input current should be limited to less than 10 mA.

(3) A heat sink may be required to keep the junction temperature below the absolute maximum rating. This depends on the power dissipation of the application. Thermal resistance varies with the amount of PC board metal connected to the package.

ESD, Electrostatic Discharge Protection

Parameter		Condition	Minimum Level	Unit
HBM	Human Body Model ESD	ANSI/ESDA/JEDEC JS-001 ⁽¹⁾	3	kV
CDM	Charged Device Model ESD	ANSI/ESDA/JEDEC JS-002 ⁽²⁾	1.5	kV

(1) JEDEC document JEP155 states that 500-V HBM allows safe manufacturing with a standard ESD control process.

(2) JEDEC document JEP157 states that 250-V CDM allows safe manufacturing with a standard ESD control process.

Recommended Operating Conditions

Parameter		Min	Typ	Max	Unit
V _S	Supply Voltage, (+V _S) – (–V _S)	2.7 (±1.35)		5.5 (±2.75)	V
T _A	Operating Temperature Range	–40		125	°C

Thermal Information

Package Type	θ _{JA}	θ _{JC}	Unit
SOT353 (SC70-5)	400	150	°C/W
SOT23-5	250	81	°C/W

5-V, Zero-Drift Operational Amplifiers

Package Type	θ_{JA}	θ_{JC}	Unit
SOP8	158	43	°C/W
MSOP8	210	45	°C/W

Electrical Characteristics

 All test conditions: $V_S = 5\text{ V}$, $T_A = 25^\circ\text{C}$, $R_L = 10\text{ k}\Omega$, unless otherwise noted.

Parameter	Conditions	Min	Typ	Max	Unit
Power Supply					
V_S	Supply Voltage Range	2.7		5.5	V
I_Q	Quiescent Current per Amplifier	$V_S = 5\text{ V}$	0.5	1	mA
		$V_S = 5\text{ V}$, $T_A = -40^\circ\text{C}$ to 125°C		1.2	mA
PSRR	Power Supply Rejection Ratio	$V_S = 2.7\text{ V}$ to 5.5 V , $V_{CM} = 0\text{ V}$	114	124	dB
		$V_S = 2.7\text{ V}$ to 5.5 V , $V_{CM} = 0\text{ V}$, $T_A = -40^\circ\text{C}$ to 125°C	110		dB
Input Characteristics					
V_{OS}	Input Offset Voltage	$V_S = 3.3\text{ V}$, $V_{CM} = 0$ to 3.3 V	-10	10	μV
		$V_S = 3.3\text{ V}$, $V_{CM} = 0$ to 3.3 V , $T_A = -40^\circ\text{C}$ to 125°C	-20	20	μV
		$V_S = 5\text{ V}$, $V_{CM} = 0$ to 5 V	-10	10	μV
		$V_S = 5\text{ V}$, $V_{CM} = 0$ to 5 V , $T_A = -40^\circ\text{C}$ to 125°C	-20	20	μV
V_{OSTC}	Input Offset Voltage Drift	$T_A = -40^\circ\text{C}$ to 125°C	0.01		$\mu\text{V}/^\circ\text{C}$
I_B	Input Bias Current	$V_S = 5\text{ V}$, $V_{CM} = 2.5\text{ V}$	200	1000	pA
		$V_S = 5\text{ V}$, $V_{CM} = 2.5\text{ V}$, $T_A = -40^\circ\text{C}$ to 125°C	300	1300	pA
I_{OS}	Input Offset Current	$V_S = 5\text{ V}$, $V_{CM} = 2.5\text{ V}$	100	600	pA
		$V_S = 5\text{ V}$, $V_{CM} = 2.5\text{ V}$, $T_A = -40^\circ\text{C}$ to 125°C		850	pA
C_{IN}	Input Capacitance	Differential Mode		5	pF
		Common Mode		2.5	pF
A_v	Open-Loop Voltage Gain	$R_{LOAD} = 10\text{ k}\Omega$, $V_{OUT} = 0.5\text{ V}$ to 4.5 V	120	150	dB
		$R_{LOAD} = 10\text{ k}\Omega$, $V_{OUT} = 0.5\text{ V}$ to 4.5 V , $T_A = -40^\circ\text{C}$ to 125°C	115		dB
V_{CMR}	Common-Mode Input Voltage Range	(V-) - 0.1		(V+) + 0.1	V
CMRR	Common Mode Rejection Ratio	$V_{CM} = 0\text{ V}$ to 5 V	115	140	dB
		$V_{CM} = 0\text{ V}$ to 5 V , $T_A = -40^\circ\text{C}$ to 125°C	110		dB

5-V, Zero-Drift Operational Amplifiers

 All test conditions: $V_S = 5\text{ V}$, $T_A = 25^\circ\text{C}$, $R_L = 10\text{ k}\Omega$, unless otherwise noted.

Symbol	Parameter	Conditions	Min	Typ	Max	Unit
Output Characteristics						
	Output Swing from Positive Rail	$R_{LOAD} = 10\text{ k}\Omega$ to $V_S/2$		10	20	mV
		$R_{LOAD} = 10\text{ k}\Omega$ to $V_S/2$, $T_A = -40^\circ\text{C}$ to 125°C			25	mV
		$R_{LOAD} = 2\text{ k}\Omega$ to $V_S/2$		45	100	mV
		$R_{LOAD} = 2\text{ k}\Omega$ to $V_S/2$, $T_A = -40^\circ\text{C}$ to 125°C			120	mV
	Output Swing from Negative Rail	$R_{LOAD} = 10\text{ k}\Omega$ to $V_S/2$		10	20	mV
		$R_{LOAD} = 10\text{ k}\Omega$ to $V_S/2$, $T_A = -40^\circ\text{C}$ to 125°C			25	mV
		$R_{LOAD} = 2\text{ k}\Omega$ to $V_S/2$		25	50	mV
		$R_{LOAD} = 2\text{ k}\Omega$ to $V_S/2$, $T_A = -40^\circ\text{C}$ to 125°C			80	mV
I_{sc}	Output Short-Circuit Current	Sink or Source	40	60		mA
		Sink or Source, $T_A = -40^\circ\text{C}$ to 125°C	30			mA
AC Specifications						
GBW	Gain-Bandwidth Product			3.5		MHz
SR	Slew Rate	$G = 1$		4.7		V/ μs
t_{OR}	Overload Recovery			0.8		μs
t_s	Settling Time, 0.1%	$G = 1$, 2V Step		8		μs
PM	Phase Margin	$R_L = 10\text{ k}\Omega$, $C_L = 100\text{ pF}$		70		$^\circ$
GM	Gain Margin	$R_L = 10\text{ k}\Omega$, $C_L = 100\text{ pF}$		15		dB
Noise Performance						
E_N	Input Voltage Noise	$f = 0.1\text{ Hz}$ to 10 Hz		0.25		μV_{PP}
e_N	Input Voltage Noise Density	$f = 1\text{ kHz}$		12		nV/ $\sqrt{\text{Hz}}$
i_N	Input Current Noise Density	$f = 1\text{ kHz}$		100		fA/ $\sqrt{\text{Hz}}$
THD+N	Total Harmonic Distortion and Noise	$f = 1\text{ kHz}$, $G = 1$, $R_L = 2\text{ k}\Omega$, $V_{OUT} = 1\text{ V}_{RMS}$		0.005		%

Typical Performance Characteristics

All test conditions: $V_S = 5\text{ V}$, $T_A = 25^\circ\text{C}$, unless otherwise noted.

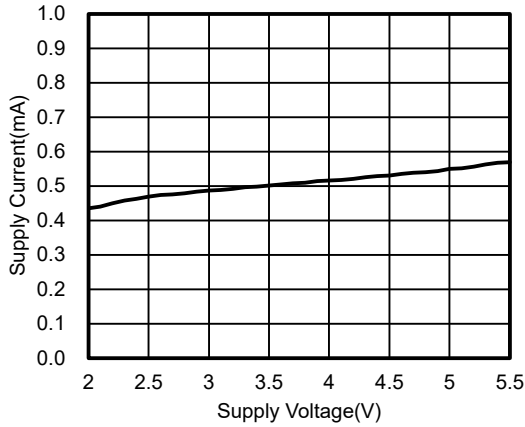

Figure 1. Supply Current vs Supply Voltage, 1ch

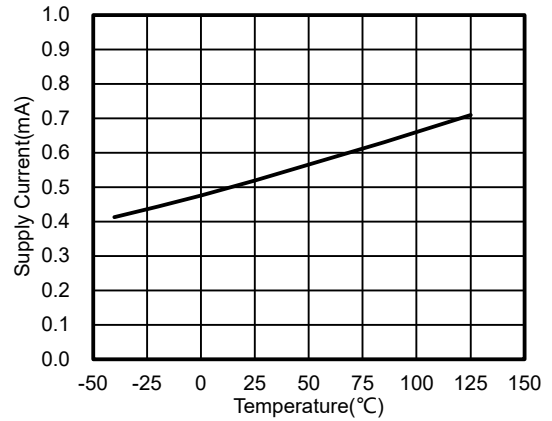

Figure 2. Supply Current vs Temperature, 1ch

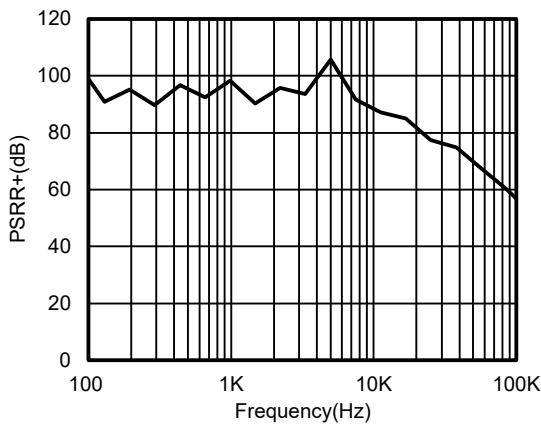

Figure 3. PSRR+ vs Frequency

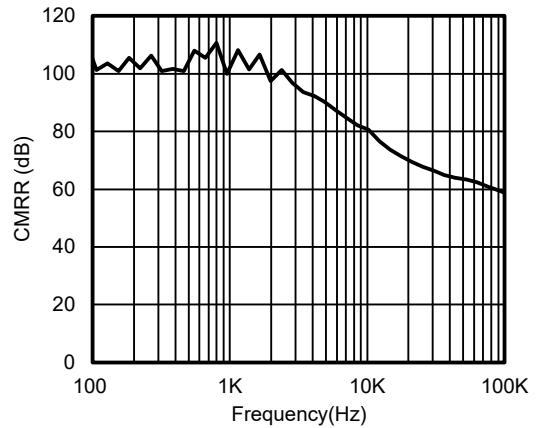

Figure 4. PSRR- vs Frequency

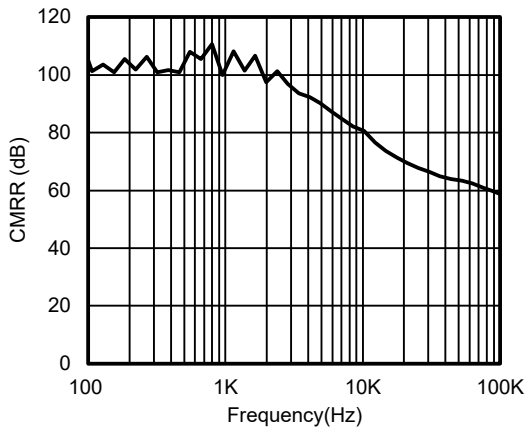

Figure 5. CMRR vs Frequency

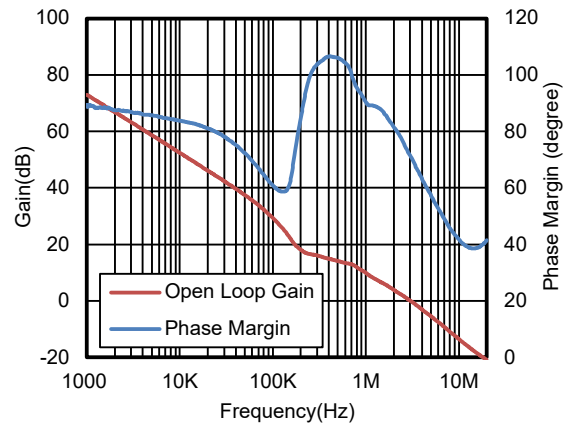

Figure 6. Open Loop Gain and Phase Margin vs Frequency, $R_L = 10\text{ k}\Omega$, $C_L = 100\text{ pF}$

5-V, Zero-Drift Operational Amplifiers

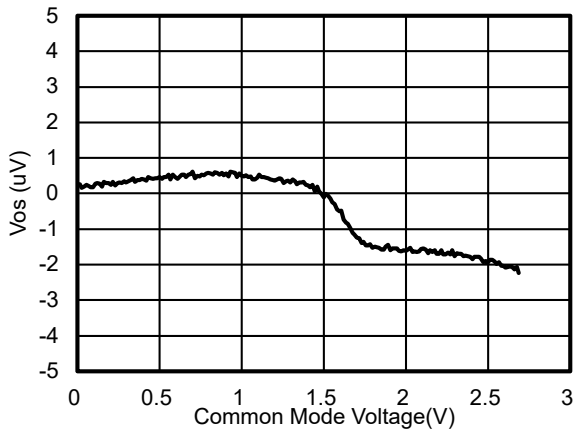

Figure 7. V_{os} vs V_{cm} , $V_s = 2.7\text{ V}$

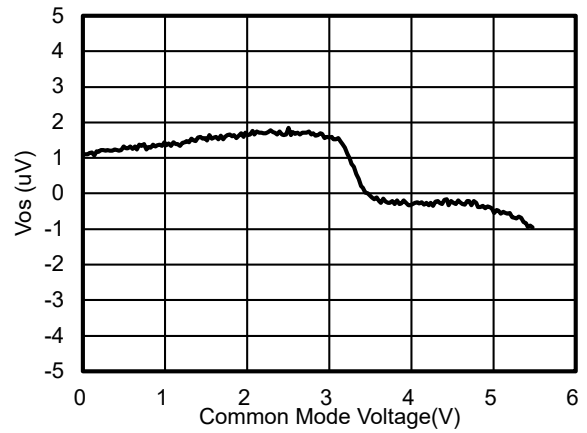

Figure 8. V_{os} vs V_{cm} , $V_s = 5.5\text{ V}$

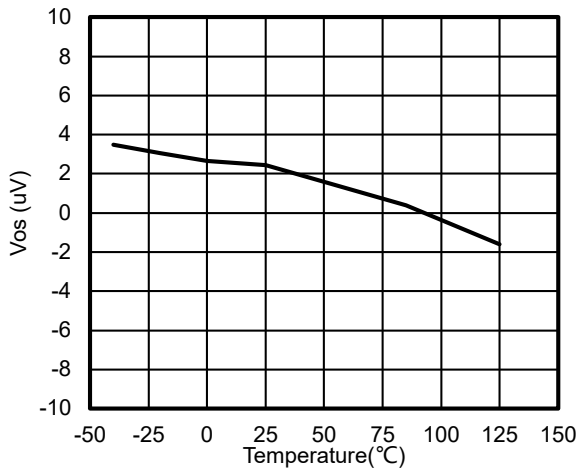

Figure 9. V_{os} vs Temperature

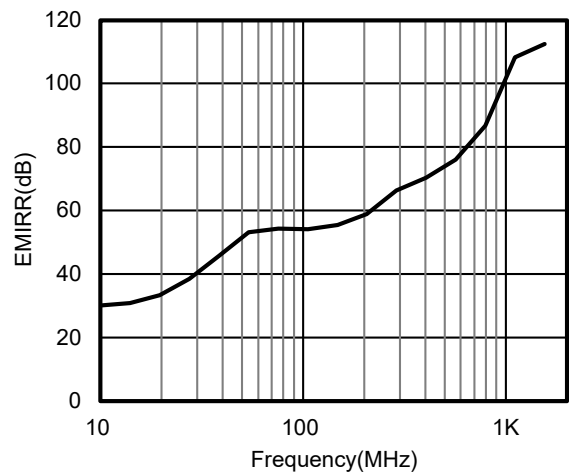

Figure 10. EMIRR vs Frequency

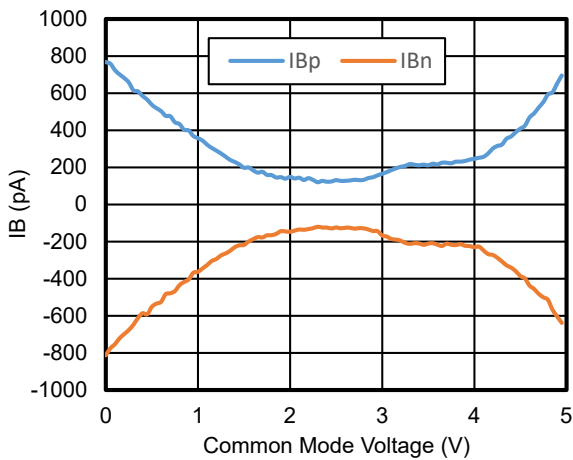

Figure 11. I_B vs Common-Mode Voltage

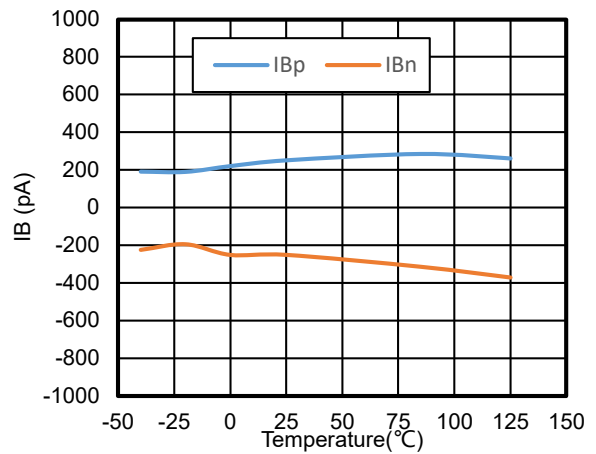

Figure 12. I_B vs Temperature

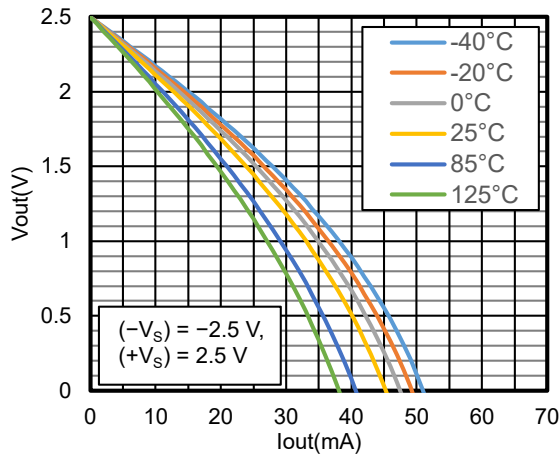

Figure 13. Output Voltage vs Output Current

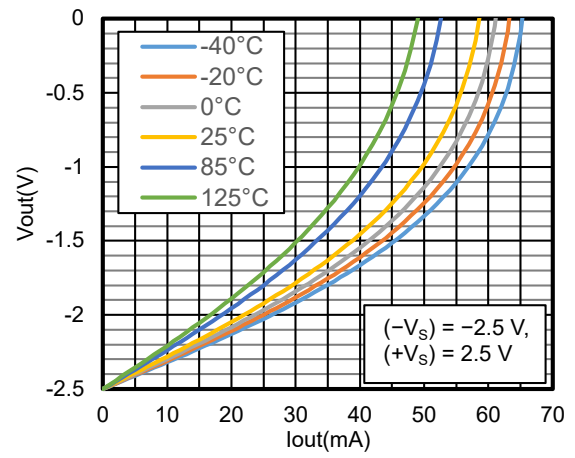

Figure 14. Output Voltage vs Output Current

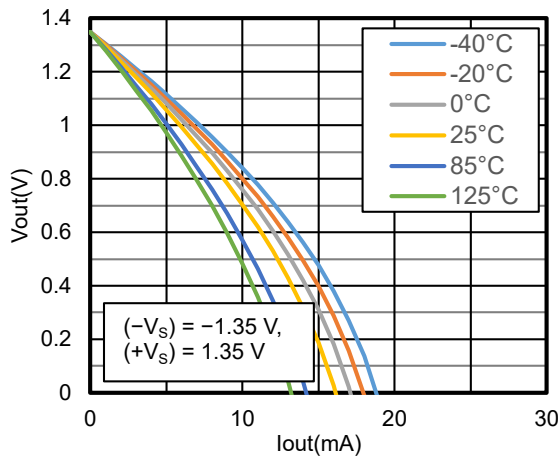

Figure 15. Output Voltage vs Output Current

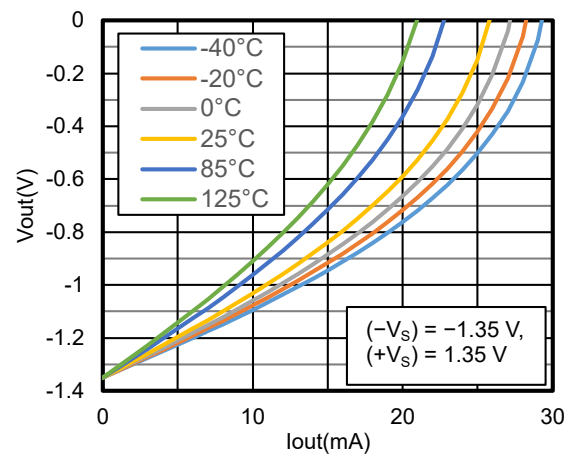

Figure 16. Output Voltage vs Output Current

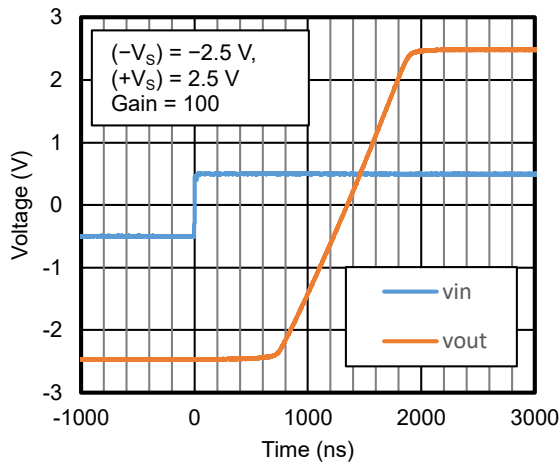

Figure 17. Overload Recovery at Negative Rail

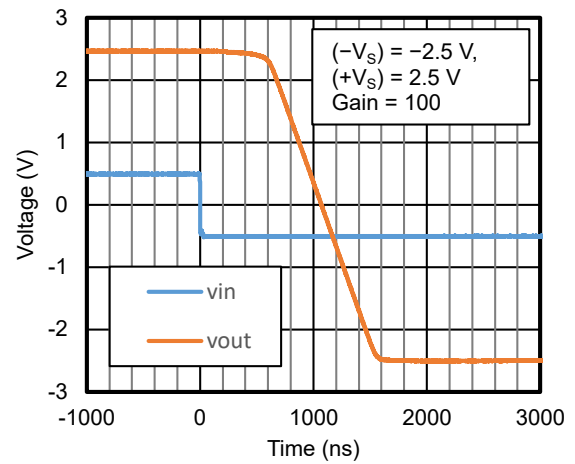

Figure 18. Overload Recovery at Positive Rail

5-V, Zero-Drift Operational Amplifiers

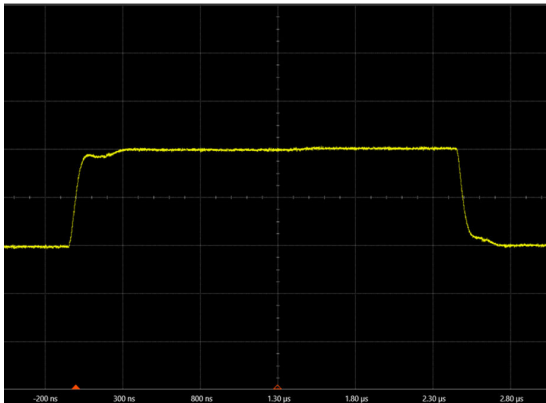

Figure 19. 100-mV Small Signal Step Response Voltage:
50 mV/div, Time: 500 ns/div

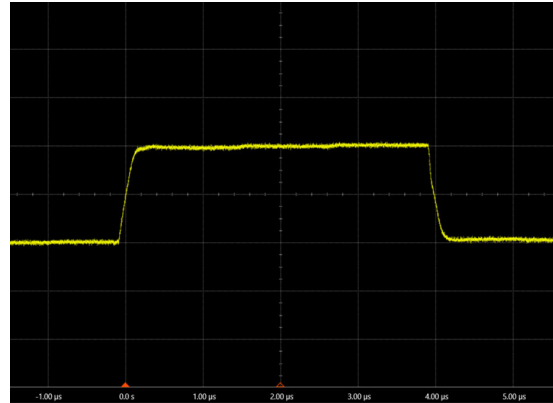

Figure 20. 1-V Large Signal Step Response Voltage: 500
mV/div, Time: 1 μs/div

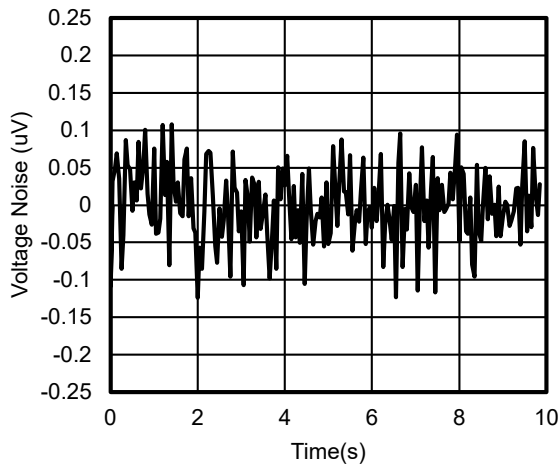

Figure 21. 0.1 to 10 Hz Voltage Noise

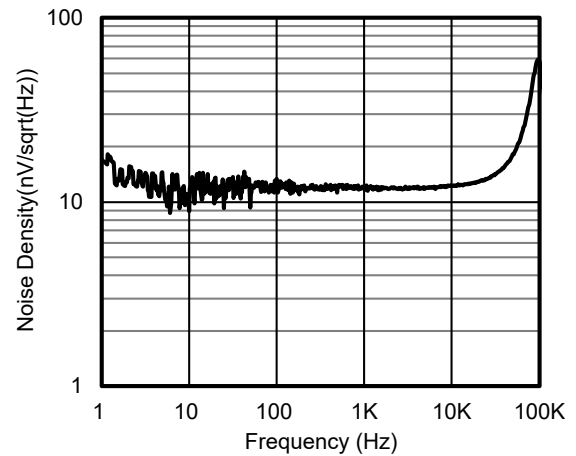

Figure 22. Voltage Noise Spectral Density vs Frequency

Detailed Description

Overview

The TPA556x series of op amps can operate on a single-supply voltage (2.7 V to 5.5 V), or a split-supply voltage (± 1.35 V to ± 2.75 V), making them highly versatile and easy to use. The power-supply pins have local bypass ceramic capacitors (typically 0.01 μ F to 0.1 μ F). These amplifiers are fully specified from 2.7 V to 5.5 V and over the extended temperature range of -40°C to $+125^{\circ}\text{C}$.

Functional Block Diagram

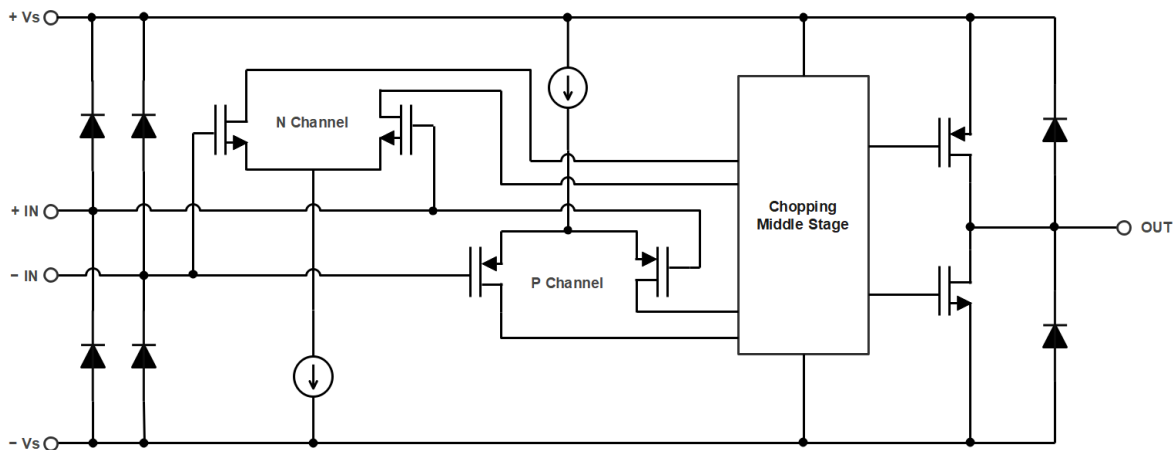

Figure 23. Functional Block Diagram

Feature Description

Operating Voltage

The devices are designed for single supply operation from 2.7 V to 5.5 V or dual supply operation from ± 1.35 V to ± 2.75 V.

Ultra Low Offset Voltage and Offset Voltage Drift in Operating Temperature Range

The devices provide 45- μ V offset voltage within the temperature range from -40°C to 125°C , which is achieved through the chopper stabilized technology. This unique topology allows the devices to maintain their low-offset voltage over a wide temperature range and over their operating lifetime.

Low 1/f Noise

Flicker noise, as known as 1/f noise, is inherent in semiconductor devices and increases as frequency decreases. The flicker noise provides higher degrees of error for low-frequency applications. The devices use the chopper stabilized technology to reduce flicker noise. This reduction in 1/f noise allows the devices to have lower noise at dc and low-frequency range compared to standard amplifier.

Residual Voltage Ripple

The chopping technique can be used in amplifier design due to the internal notch filter. Although the chopping related voltage ripple is suppressed, higher noise spectrum exists at the chopping frequency and its harmonics due to residual ripple.

5-V, Zero-Drift Operational Amplifiers

The devices set the chopping frequency to 450 kHz. If the frequency of input signal is close to the chopping frequency, the signal may be interfered by the residue ripple. To suppress the noise at the chopping frequency, it is recommended that a post filter to be placed at the output of the amplifier.

Rail-to-Rail Input

The input common-mode voltage range of the devices extends 100 mV beyond the supply rails. This performance is achieved with a complementary input stage: a PMOS input differential pair in parallel with an NMOS input differential pair.

Rail-to-Rail Output

The devices deliver rail-to-rail output swing capability with a class-AB output stage. Different load conditions change the ability of the amplifier to swing close to the rails.

Application and Implementation

Note

Information in the following application sections is not part of the 3PEAK's component specification and 3PEAK does not warrant its accuracy or completeness. 3PEAK's customers are responsible for determining suitability of components for their purposes. Customers should validate and test their design implementation to confirm system functionality.

Application Information

Low-Side Current Sensing Application

Figure 24 shows the device configured in a low-side current sensing application. The low-side current sensing method consists of placing a sense resistor between the load and the circuit ground. The voltage dropping across the resistor is amplified by different amplifier circuits with the device. The V_{REF} can be used to add bias voltage to the output voltage. Particular attention must be paid to the matching and precision of R1, R2, R3, and R4, to maximize the accuracy of the measurement.

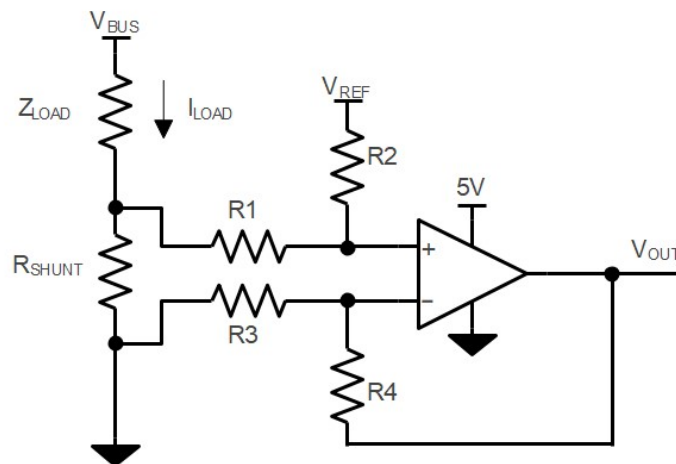

$$V_{OUT} = (I_{LOAD} \times R_{SHUNT}) \times (R2 / R1) + V_{REF}$$

$$\text{When } R3 = R1, R2 = R4, R_{SHUNT} \ll R1$$

Figure 24. Low-Side Current Sensing Application

Power Supply Recommendations

Place 0.1- μ F bypass capacitors close to the power supply pins for reducing coupling errors from the noisy or high-impedance power supplies.

Tape and Reel Information

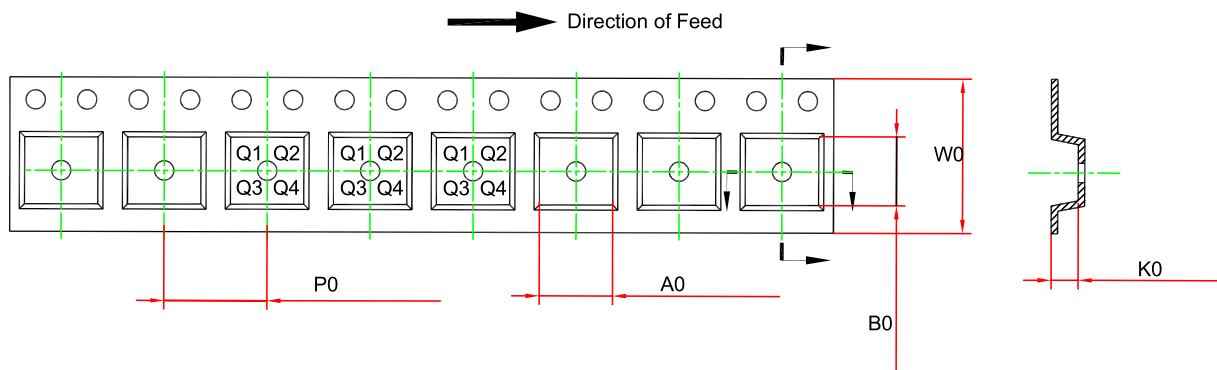
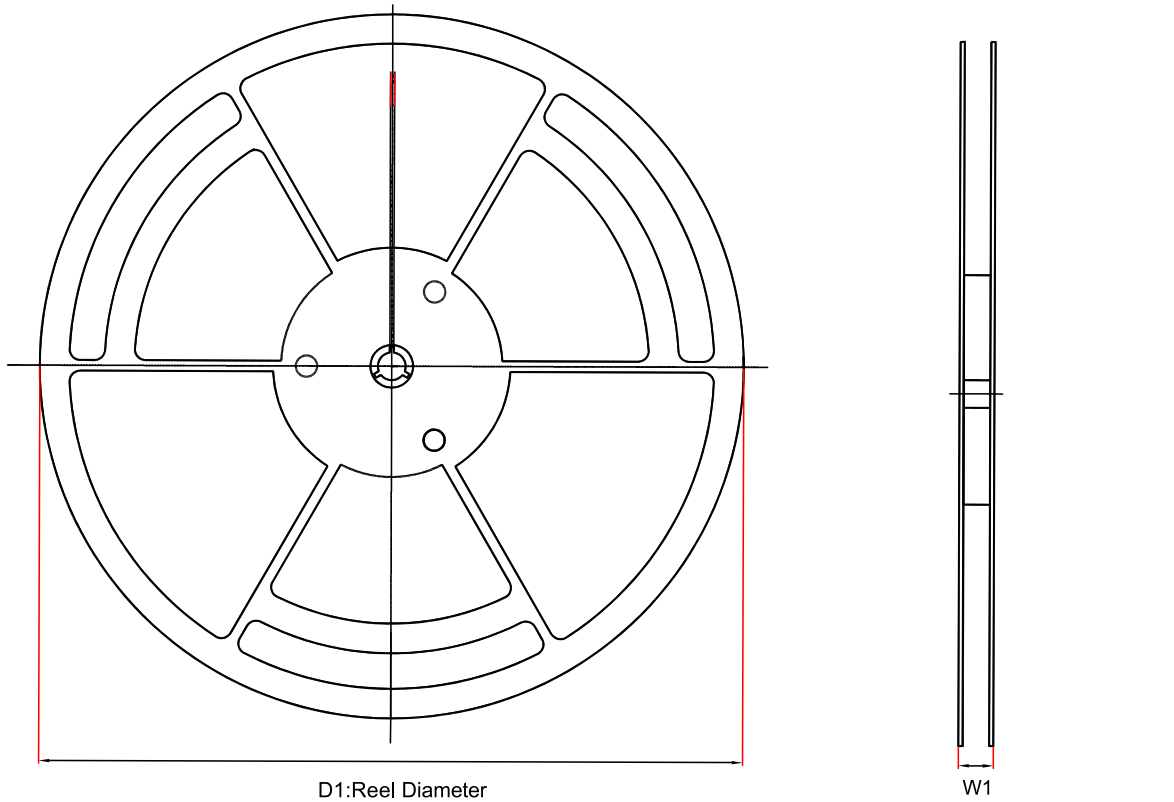

Order Number	Package	D1 (mm)	W1 (mm)	A0 (mm)	B0 (mm)	K0 (mm)	P0 (mm)	W0 (mm)	Pin1 Quadrant
TPA5561-SC5R	SOT353 (SC70-5)	178.0	12.3	2.4	2.5	1.2	4.0	8.0	Q3
TPA5561U-SC5R	SOT353 (SC70-5)	178.0	12.3	2.4	2.5	1.2	4.0	8.0	Q3
TPA5561-S5TR	SOT23-5	178.0	11.4	3.3	3.2	1.4	4.0	8.0	Q3
TPA5561U-S5TR	SOT23-5	178.0	11.4	3.3	3.2	1.4	4.0	8.0	Q3
TPA5562-SO1R	SOP8	330.0	16.8	6.5	5.4	2	8.0	12.0	Q1
TPA5562-TS1R	TSSOP8	330.0	17.6	6.8	3.3	1.2	8.0	12.0	Q1

Order Number	Package	D1 (mm)	W1 (mm)	A0 (mm)	B0 (mm)	K0 (mm)	P0 (mm)	W0 (mm)	Pin1 Quadrant
TPA5562-VS1R	MSOP8	330.0	17.6	5.2	3.3	1.5	8.0	12.0	Q1

Package Outline Dimensions

SOT23-5

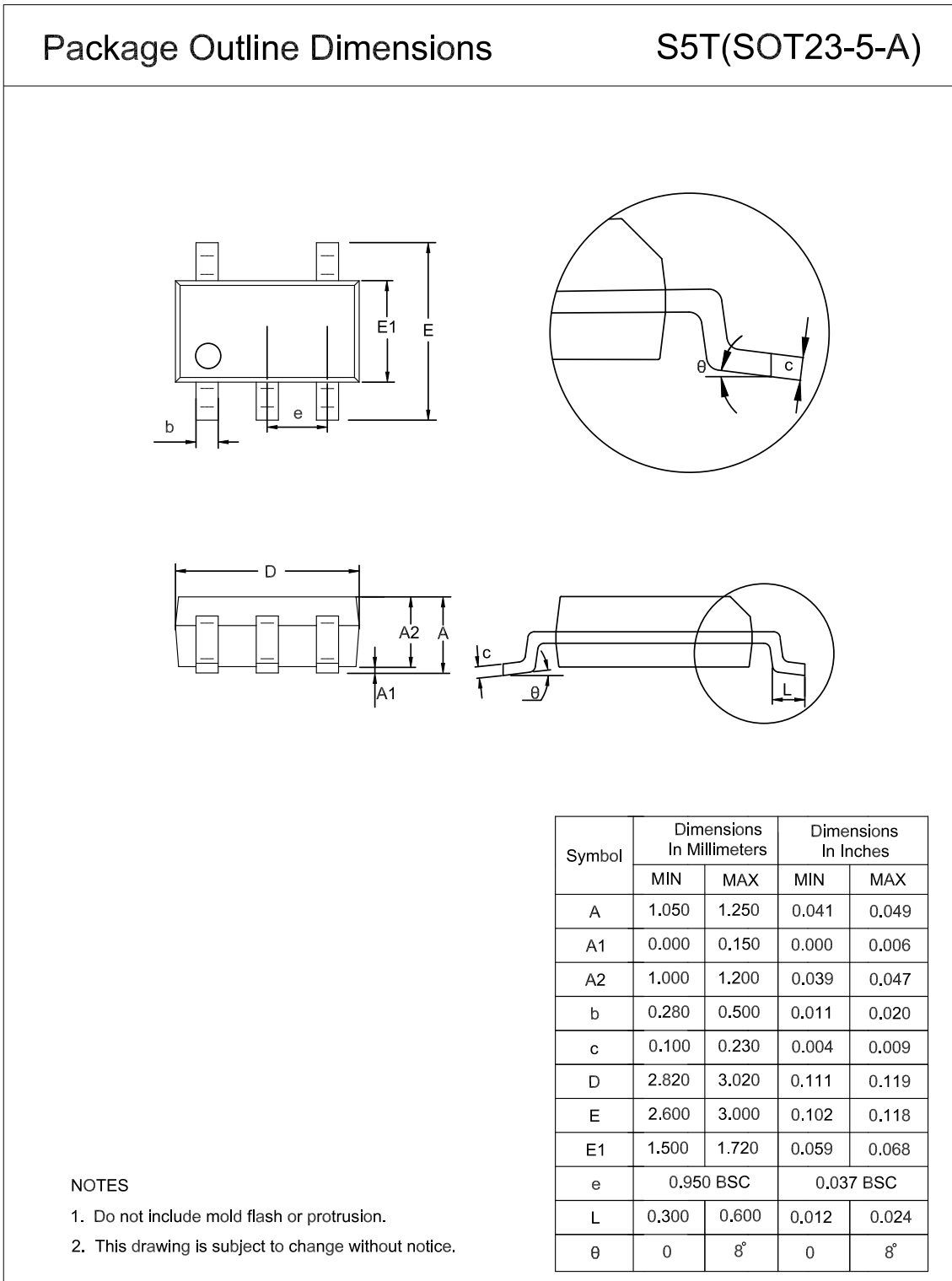

SOT353

Package Outline Dimensions

SC5(SOT353-5-A)

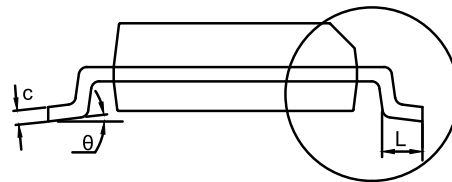
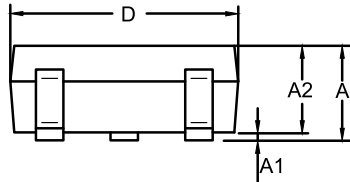
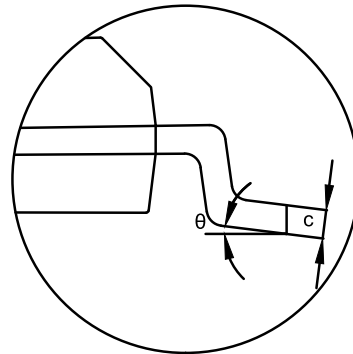
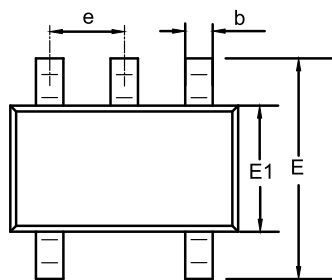

Symbol	Dimensions In Millimeters		Dimensions In Inches	
	MIN	MAX	MIN	MAX
A	0.850	1.100	0.033	0.043
A1	0.000	0.100	0.000	0.004
A2	0.800	1.000	0.031	0.039
b	0.150	0.350	0.006	0.014
c	0.110	0.230	0.004	0.009
D	2.000	2.200	0.079	0.087
E	2.150	2.450	0.085	0.096
E1	1.150	1.350	0.045	0.053
e	0.650 BSC		0.026 BSC	
L	0.260	0.460	0.010	0.018
θ	0	8°	0	8°

NOTES

1. Do not include mold flash or protrusion.
2. This drawing is subject to change without notice.

TSSOP8

Package Outline Dimensions

TS1(TSSOP-8-A)

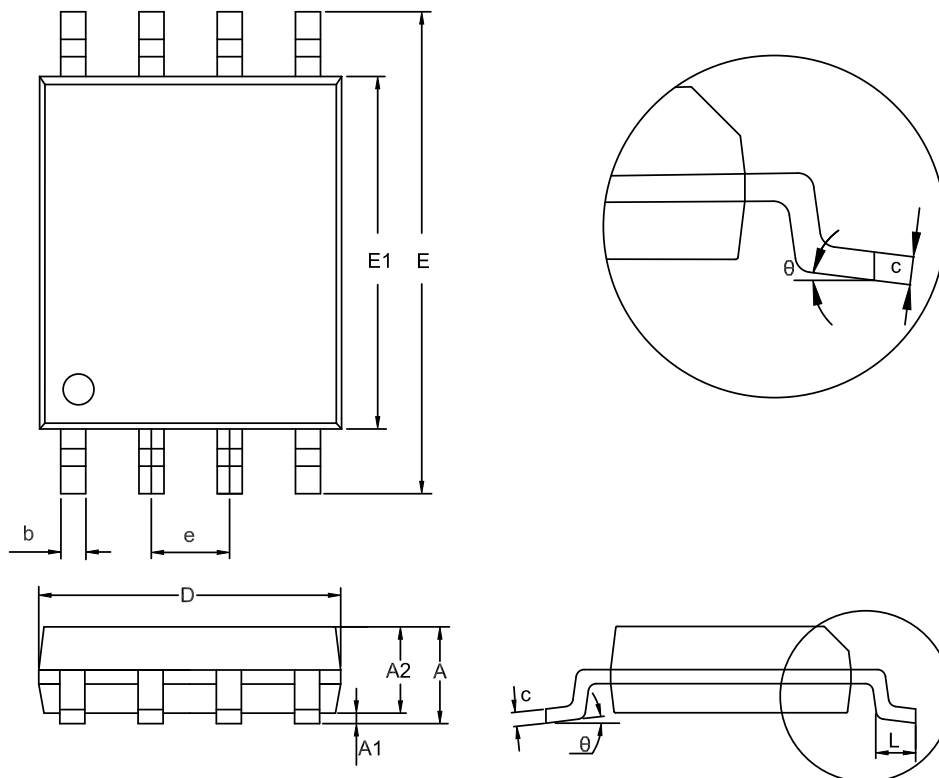

Symbol	Dimensions In Millimeters		Dimensions In Inches	
	MIN	MAX	MIN	MAX
A	0.900	1.200	0.035	0.047
A1	0.050	0.150	0.002	0.006
A2	0.800	1.050	0.031	0.041
b	0.190	0.300	0.007	0.012
c	0.090	0.200	0.004	0.008
D	2.900	3.100	0.114	0.122
E	6.200	6.600	0.244	0.260
E1	4.300	4.500	0.169	0.177
e	0.650 BSC		0.026 BSC	
L	0.450	0.750	0.018	0.030
theta	0	8°	0	8°

NOTES

1. Do not include mold flash or protrusion.
2. This drawing is subject to change without notice.

MSOP8

Package Outline Dimensions

VS1(MSOP-8-A)

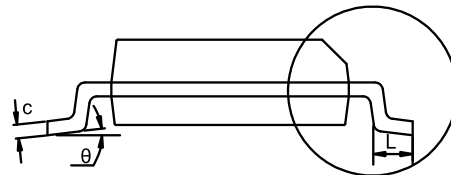
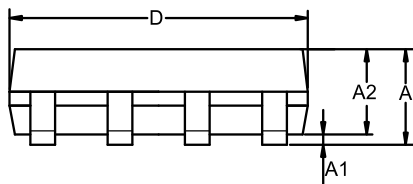
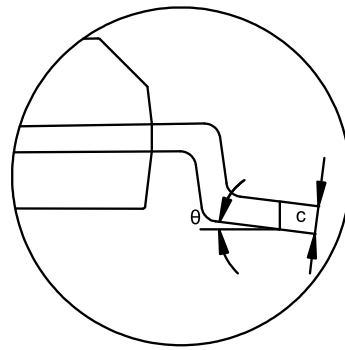
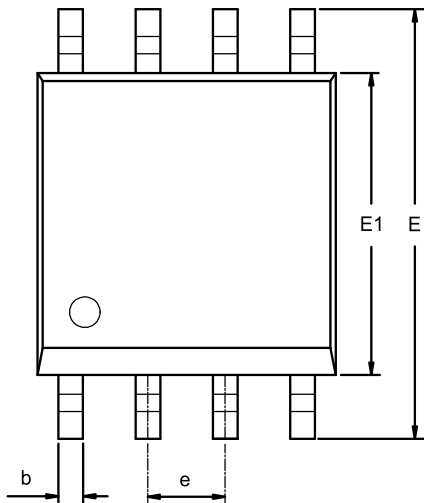

Symbol	Dimensions In Millimeters		Dimensions In Inches	
	MIN	MAX	MIN	MAX
A	0.800	1.100	0.031	0.043
A1	0.020	0.150	0.001	0.006
A2	0.750	0.950	0.030	0.037
b	0.250	0.380	0.010	0.015
c	0.090	0.230	0.004	0.009
D	2.900	3.100	0.114	0.122
E	4.700	5.100	0.185	0.201
E1	2.900	3.100	0.114	0.122
e	0.650 BSC		0.026 BSC	
L	0.400	0.800	0.016	0.031
θ	0	8°	0	8°

NOTES

1. Do not include mold flash or protrusion.
2. This drawing is subject to change without notice.

SOP8

Package Outline Dimensions

SO1(SOP-8-A)

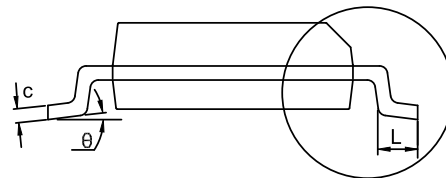
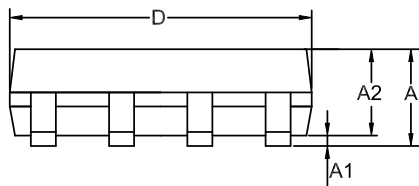
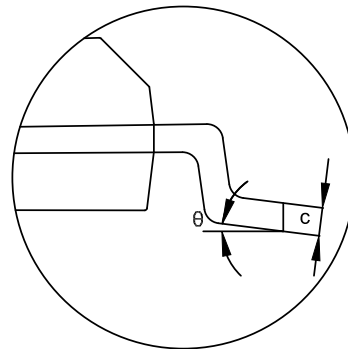
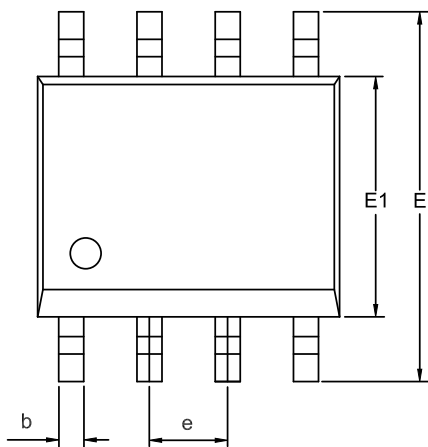

Symbol	Dimensions In Millimeters		Dimensions In Inches	
	MIN	MAX	MIN	MAX
A	1.350	1.750	0.053	0.069
A1	0.050	0.250	0.002	0.010
A2	1.250	1.550	0.049	0.061
b	0.330	0.510	0.013	0.020
c	0.170	0.250	0.007	0.010
D	4.700	5.100	0.185	0.201
E	5.800	6.200	0.228	0.244
E1	3.800	4.000	0.150	0.157
e	1.270 BSC		0.050 BSC	
L	0.400	1.000	0.016	0.039
θ	0	8°	0	8°

NOTES

1. Do not include mold flash or protrusion.
2. This drawing is subject to change without notice.

Order Information

Order Number	Operating Temperature Range	Package	Marking Information	MSL	Transport Media, Quantity	Eco Plan
TPA5561-SC5R	-40 to 125°C	SOT353 (SC70-5)	561	3	Tape and Reel, 3000	Green
TPA5561U-SC5R	-40 to 125°C	SOT353 (SC70-5)	56U	3	Tape and Reel, 3000	Green
TPA5561-S5TR	-40 to 125°C	SOT23-5	561	3	Tape and Reel, 3000	Green
TPA5561U-S5TR	-40 to 125°C	SOT23-5	56U	3	Tape and Reel, 3000	Green
TPA5562-SO1R	-40 to 125°C	SOP8	A5562	3	Tape and Reel, 4000	Green
TPA5562-TS1R	-40 to 125°C	TSSOP8	A5562	3	Tape and Reel, 3000	Green
TPA5562-VS1R	-40 to 125°C	MSOP8	A5562	3	Tape and Reel, 3000	Green

Green: 3PEAK defines "Green" to mean RoHS compatible and free of halogen substances.

IMPORTANT NOTICE AND DISCLAIMER

Copyright© 3PEAK 2012-2023. All rights reserved.

Trademarks. Any of the 思瑞浦 or 3PEAK trade names, trademarks, graphic marks, and domain names contained in this document /material are the property of 3PEAK. You may NOT reproduce, modify, publish, transmit or distribute any Trademark without the prior written consent of 3PEAK.

Performance Information. Performance tests or performance range contained in this document/material are either results of design simulation or actual tests conducted under designated testing environment. Any variation in testing environment or simulation environment, including but not limited to testing method, testing process or testing temperature, may affect actual performance of the product.

Disclaimer. 3PEAK provides technical and reliability data (including data sheets), design resources (including reference designs), application or other design recommendations, networking tools, security information and other resources "As Is". 3PEAK makes no warranty as to the absence of defects, and makes no warranties of any kind, express or implied, including without limitation, implied warranties as to merchantability, fitness for a particular purpose or non-infringement of any third-party's intellectual property rights. Unless otherwise specified in writing, products supplied by 3PEAK are not designed to be used in any life-threatening scenarios, including critical medical applications, automotive safety-critical systems, aviation, aerospace, or any situations where failure could result in bodily harm, loss of life, or significant property damage. 3PEAK disclaims all liability for any such unauthorized use.

This page intentionally left blank