

Features

- Input Voltage Range: 1.75 V to 5.5 V
- Output Voltage Range: 0.9 V to 5 V
- $\pm 2.5\%$ Output Accuracy Over Line, Load Regulation, and Operating Temperature Range
- 500 mA Maximum Output Current
- Low Dropout Voltage: 150 mV typical at 500 mA
- High PSRR:
 - 82 dB at 1 kHz
 - 88 dB at 10 kHz
 - 61 dB at 100 kHz
 - 45 dB at 1 MHz
- 8.6 μV_{RMS} Output Voltage Noise
- Excellent Transient Response
- Stable with a 1 μF or Larger Ceramic Output Capacitor
- Output Reverse Current Protection
- Output Shortage Protection
- Over-Temperature and Over-Current Protection
- Junction Temperature Range: -40°C to $+125^{\circ}\text{C}$
- Package Options:
 - SOT23-5
 - DFN1X1-4

Application

- Portable and Battery-Powered Equipment
- Mobile Phones and Tablets
- Digital Cameras and Audio Devices Power Supply
- Video Surveillance

Description

The TPL9052 series products are 500-mA high PSRR, ultra-low noise, low dropout linear regulators with high output accuracy. The TPL9052 series products support both fixed output voltage ranges from 0.9 V to 5 V and is stable with 1 μF or larger ceramic output capacitor.

The TPL9052 series products have high PSRR with 88 dB at 10 kHz and 8.6 μV_{RMS} ultra-low noise. These features make TPL9052 series products very suitable for noise-sensitive applications with high noise from previous stage power supply, such as high-performance analog devices, or high-definition imaging equipment.

The TPL9052 series products integrate protection features: output reverse current protection, output shortage protection, over-temperature protection and overload protection. All these features significantly improve the system reliability and simplify circuitry design under different operating conditions.

The TPL9052 series products provide SOT23-5, and DFN1X1-4 packages with guaranteed operating junction temperature range (T_J) from -40°C to $+125^{\circ}\text{C}$.

Typical Application Schematic

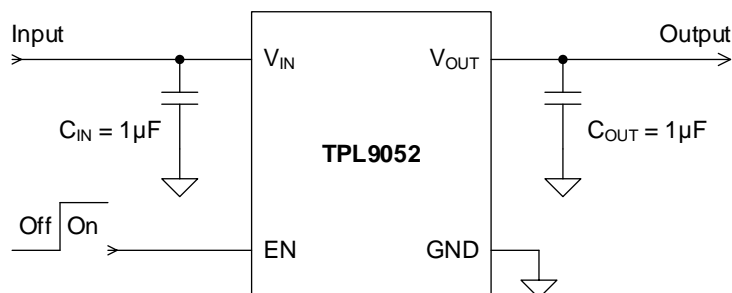

Product Family Table

Order Number	Output Voltage (V)	Package
TPL905209-S5TR	0.9 V	SOT23-5
TPL905210-S5TR	1.0 V	SOT23-5
TPL905211-S5TR	1.1 V	SOT23-5
TPL905212-S5TR	1.2 V	SOT23-5
TPL905213-S5TR	1.3 V	SOT23-5
TPL905215-S5TR	1.5 V	SOT23-5
TPL905216-S5TR	1.6 V	SOT23-5
TPL905218-S5TR	1.8 V	SOT23-5
TPL905219-S5TR	1.9 V	SOT23-5
TPL905221-S5TR	2.1 V	SOT23-5
TPL905222-S5TR	2.2 V	SOT23-5
TPL905224-S5TR	2.4 V	SOT23-5
TPL905225-S5TR	2.5 V	SOT23-5
TPL905226-S5TR	2.6 V	SOT23-5
TPL905227-S5TR	2.7 V	SOT23-5
TPL905228-S5TR	2.8 V	SOT23-5
TPL905229-S5TR	2.9 V	SOT23-5
TPL905230-S5TR	3.0 V	SOT23-5
TPL905231-S5TR	3.1 V	SOT23-5
TPL905232-S5TR	3.2 V	SOT23-5
TPL905233-S5TR	3.3 V	SOT23-5
TPL905235-S5TR	3.5 V	SOT23-5
TPL905236-S5TR	3.6 V	SOT23-5
TPL905237-S5TR	3.7 V	SOT23-5
TPL905240-S5TR	4.0 V	SOT23-5
TPL905245-S5TR	4.5 V	SOT23-5
TPL905250-S5TR	5.0 V	SOT23-5

Order Number	Output Voltage (V)	Package
TPL905209-DF1R	0.9 V	DFN1X1-4
TPL905210-DF1R	1.0 V	DFN1X1-4
TPL905211-DF1R	1.1 V	DFN1X1-4
TPL905212-DF1R	1.2 V	DFN1X1-4
TPL905213-DF1R	1.3 V	DFN1X1-4
TPL905215-DF1R	1.5 V	DFN1X1-4
TPL905216-DF1R	1.6 V	DFN1X1-4
TPL905218-DF1R	1.8 V	DFN1X1-4
TPL905219-DF1R	1.9 V	DFN1X1-4
TPL905221-DF1R	2.1 V	DFN1X1-4
TPL905222-DF1R	2.2 V	DFN1X1-4
TPL905224-DF1R	2.4 V	DFN1X1-4
TPL905225-DF1R	2.5 V	DFN1X1-4
TPL905226-DF1R	2.6 V	DFN1X1-4
TPL905227-DF1R	2.7 V	DFN1X1-4
TPL905228-DF1R	2.8 V	DFN1X1-4
TPL905229-DF1R	2.9 V	DFN1X1-4
TPL905230-DF1R	3.0 V	DFN1X1-4
TPL905231-DF1R	3.1 V	DFN1X1-4
TPL905232-DF1R	3.2 V	DFN1X1-4
TPL905233-DF1R	3.3 V	DFN1X1-4
TPL905235-DF1R	3.5 V	DFN1X1-4
TPL905236-DF1R	3.6 V	DFN1X1-4
TPL905237-DF1R	3.7 V	DFN1X1-4
TPL905240-DF1R	4.0 V	DFN1X1-4
TPL905245-DF1R	4.5 V	DFN1X1-4
TPL905250-DF1R	5.0 V	DFN1X1-4

Table of Contents

Features	1
Application	1
Description	1
Typical Application Schematic	1
Product Family Table	2
Revision History	5
Pin Configuration and Functions	6
Pin Functions.....	6
Specifications	7
Absolute Maximum Ratings.....	7
ESD, Electrostatic Discharge Protection	7
Recommended Operating Conditions	7
Thermal Information	7
Electrical Characteristics	8
Typical Performance Characteristics.....	10
Detailed Description	12
Overview.....	12
Functional Block Diagram	12
Feature Description	12
Application and Implementation	14
Application Information.....	14
Typical Application	14
Layout	15
Layout Guideline.....	15
Tape and Reel Information	16
Package Outline Dimensions	17
SOT23-5	17
DFN1X1-4.....	18
Order Information	19
IMPORTANT NOTICE AND DISCLAIMER	22

Revision History

Date	Revision	Notes
2020-07-31	Rev.Pre.0	Preliminary Version
2021-11-15	Rev.A.0	Initial Released
2022-05-31	Rev.A.1	Removed WLCSP package

Pin Configuration and Functions

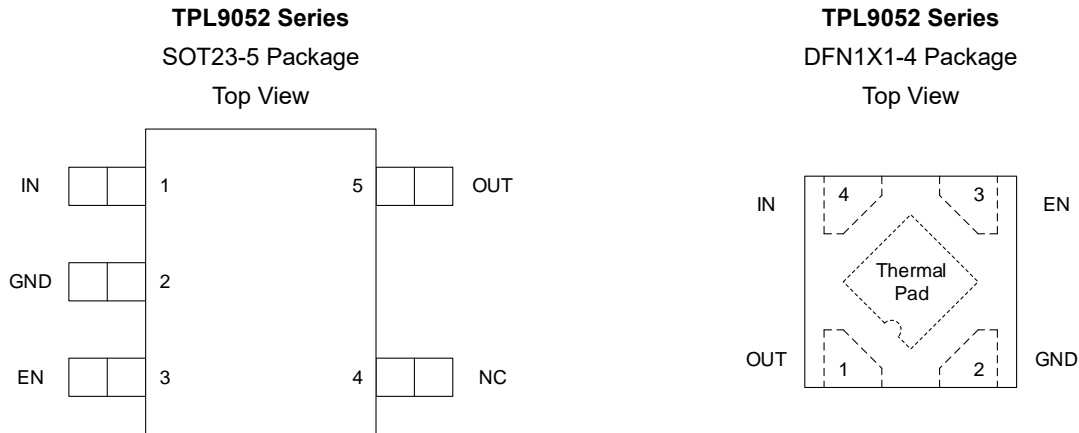

Pin Functions

Pin Name	Pin No.		I/O	Description
	SOT23-5	DFN1X1-4		
EN	3	3	I	Regulator enable pin. Drive EN high to turn on the regulator; drive EN low to turn off the regulator. For automatic startup, connect EN to IN directly.
GND	2	2	–	Ground reference pin. Connect GND pin to PCB ground plane directly.
IN	1	4	I	Input voltage pin. Bypass IN to GND with a 1 μ F or greater capacitor.
NC	4	–	–	No connection.
OUT	5	1	O	Regulated output voltage pin. Bypass OUT to GND with a 1 μ F or greater capacitor.

(1) Thermal Pad **MUST** be connected to PCB ground plane directly.

Specifications

Absolute Maximum Ratings

Parameter		Min	Max	Unit
IN, EN		-0.3	6	V
OUT		-0.3	6	V
T _J	Junction Temperature Range	-40	150	°C
T _{STG}	Storage Temperature Range	-65	150	°C
T _L	Lead Temperature (Soldering 10 sec)		260	°C

(1) Stresses beyond the Absolute Maximum Ratings may permanently damage the device.

(2) All voltage values are with respect to GND.

ESD, Electrostatic Discharge Protection

Symbol	Parameter	Condition	Minimum Level	Unit
HBM	Human Body Model ESD	ANSI/ESDA/JEDEC JS-001 ⁽¹⁾	±6000	V
CDM	Charged Device Model ESD	ANSI/ESDA/JEDEC JS-002 ⁽²⁾	±1500	V

(1) JEDEC document JEP155 states that 500-V HBM allows safe manufacturing with a standard ESD control process.

(2) JEDEC document JEP157 states that 250-V CDM allows safe manufacturing with a standard ESD control process.

Recommended Operating Conditions

Parameter		Min	Max	Unit
IN		1.75	5.5	V
EN		0	V _{IN}	V
OUT		0	5.5	V
C _{OUT}		1	10	μF
ESR of C _{OUT}		0.001	0.1	Ω
T _J	Junction Temperature Range	-40	125	°C
P _D	Power Dissipation	0	400	mW

Thermal Information

Package Type	θ _{JA}	θ _{JC}	Unit
SOT23-5	280	62	°C/W
DFN1X1-4	210	110	°C/W

Electrical Characteristics

All test condition: $V_{IN} = V_{OUT(NOM)} + 1\text{ V}$, $I_{OUT} = 1\text{ mA}$, $C_{IN} = 1\text{ }\mu\text{F}$, $C_{OUT} = 1\text{ }\mu\text{F}$, $-40^{\circ}\text{C} \leq T_J \leq +125^{\circ}\text{C}$, unless otherwise noted.

Symbol	Parameter	Conditions	Min	Typ	Max	Unit
Supply Input Voltage and Current						
V_{IN}	Input supply voltage range		1.75		5.5	V
I_{GND}	Ground pin current	$I_{OUT} = 0\text{ mA}$		120		μA
I_{SHDN}	Shutdown current	$EN = GND$		0.02	2	μA
Enable Input Voltage and Current						
$V_{IH(EN)}$	EN logic-input high level (enable)		1.2		V_{IN}	V
$V_{IL(EN)}$	EN logic-input low level (disable)		0		0.4	V
I_{EN}	EN pin leakage current	$V_{EN} = 5\text{ V}$		1	2	μA
Regulated Output Voltage and Current						
V_{OUT}	Output voltage accuracy	$-40^{\circ}\text{C} \leq T_J \leq +125^{\circ}\text{C}$, $0\text{ mA} \leq I_{OUT} \leq 300\text{ mA}$	-2%		2%	
		$-40^{\circ}\text{C} \leq T_J \leq +125^{\circ}\text{C}$, $0\text{ mA} \leq I_{OUT} \leq 500\text{ mA}$	-2.5%		2.5%	
ΔV_{OUT}	Line regulation	$V_{IN} = V_{OUT(NOM)} + 1\text{ V to } 5.5\text{ V}$		1		mV
	Load regulation	$V_{IN} = V_{OUT(NOM)} + 1\text{ V}$, $I_{OUT} = 1\text{ mA to } 500\text{ mA}$		5		mV
$V_{DO}^{(1)}$	Dropout voltage	$V_{OUT} = 3.3\text{ V}$, $I_{OUT} = 100\text{ mA}$		30		mV
		$V_{OUT} = 3.3\text{ V}$, $I_{OUT} = 300\text{ mA}$		90	180	mV
		$V_{OUT} = 3.3\text{ V}$, $I_{OUT} = 500\text{ mA}$		150	300	mV
I_{OUT}	Output voltage	V_{OUT} in regulation	0		500	mA
I_{CL}	Output current limit	$V_{OUT} = 0.9 \times V_{OUT(NOM)}$	550	800		mA
I_{SC}	Short-circuit current limit	$R_{LOAD} = 20\text{ m}\Omega$, $T_A = 25^{\circ}\text{C}$		100		mA
R_{DIS}	Active output discharge resistance	$V_{EN} < V_{IL(EN)}$		290		Ω
PSRR	Power supply rejection ratio	$I_{OUT} = 20\text{ mA}$, $f = 100\text{ Hz}$		82		dB
		$I_{OUT} = 20\text{ mA}$, $f = 1\text{ kHz}$		82		dB
		$I_{OUT} = 20\text{ mA}$, $f = 10\text{ kHz}$		88		dB
		$I_{OUT} = 20\text{ mA}$, $f = 100\text{ kHz}$		61		dB
		$I_{OUT} = 20\text{ mA}$, $f = 1\text{ MHz}$		45		dB
V_N	Output noise voltage	$I_{OUT} = 150\text{ mA}$, $BW = 10\text{ Hz to } 100\text{ kHz}$		8.6		μV_{RMS}
t_{STR}	Start-up time	V_{OUT} reaches 95% of nominal output voltage after $EN = \text{high}$		750		μs

(1) Dropout voltage is the minimum input to output voltage differential needed to maintain regulation at a specified output current and measure for $V_{OUT(NOM)} \geq 1.8\text{ V}$. In dropout, the output voltage will be equal to: $V_{IN} - V_{DROPOUT}$.

Electrical Characteristics (Continued)

All test condition: $V_{IN} = V_{OUT(NOM)} + 1\text{ V}$, $I_{OUT} = 1\text{ mA}$, $C_{IN} = 1\text{ }\mu\text{F}$, $C_{OUT} = 1\text{ }\mu\text{F}$, $-40^{\circ}\text{C} \leq T_J \leq +125^{\circ}\text{C}$, unless otherwise noted.

Symbol	Parameter	Conditions	Min	Typ	Max	Unit
Temperature Range						
T _{SD}	Thermal shutdown temperature			165		°C
	Thermal shutdown hysteresis			15		°C

Typical Performance Characteristics

All test condition: $V_{IN} = V_{OUT(NOM)} + 1\text{ V}$, $I_{OUT} = 1\text{ mA}$, $C_{IN} = 1\text{ }\mu\text{F}$, $C_{OUT} = 1\text{ }\mu\text{F}$, $-40^{\circ}\text{C} \leq T_J \leq +125^{\circ}\text{C}$, unless otherwise noted.

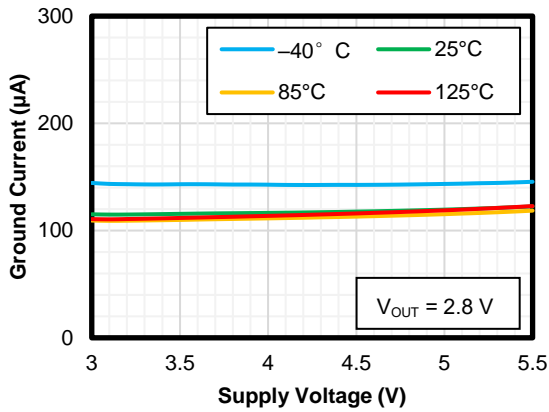

Figure 1 Quiescent Current vs Input Voltage

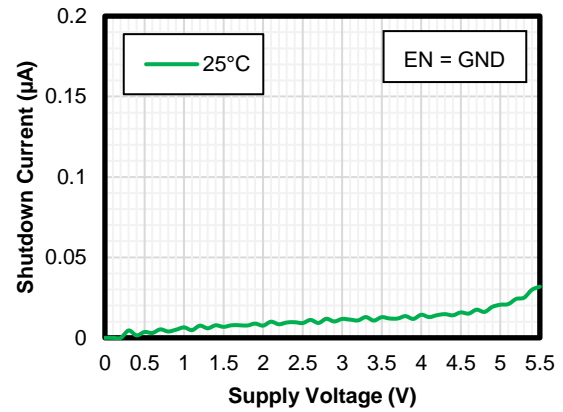

Figure 2 Quiescent Current vs Input Voltage

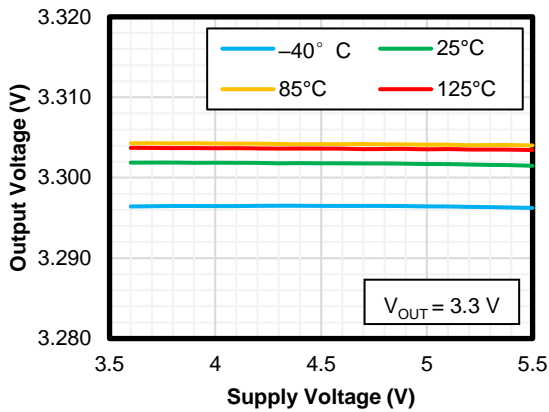

Figure 3 Line Regulation

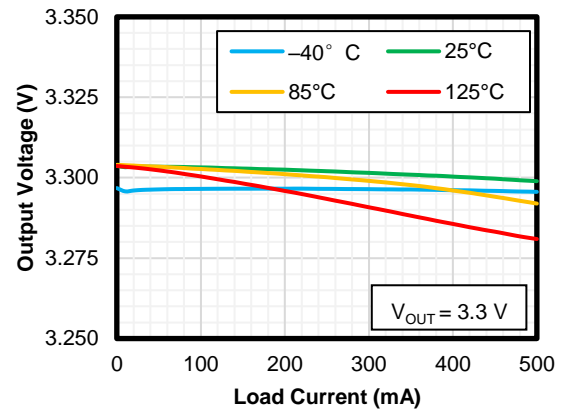

Figure 4 Load Regulation

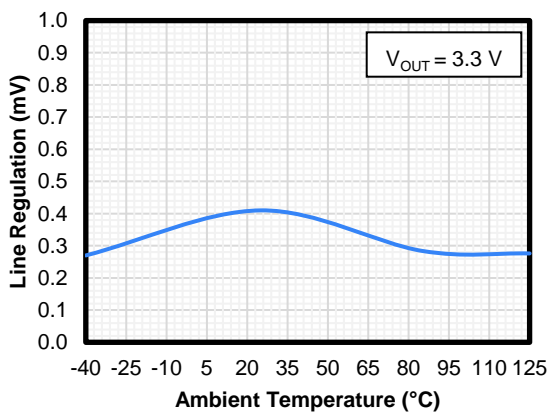

Figure 5 Line Regulation vs. Temperature

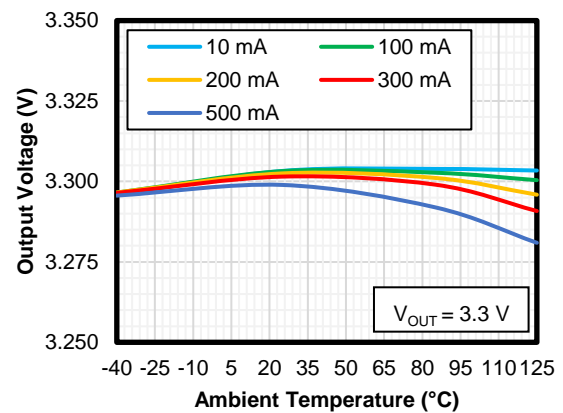

Figure 6 Output Voltage vs. Temperature

Typical Performance Characteristics (Continued)

All test condition: $V_{IN} = V_{OUT(NOM)} + 1\text{ V}$, $I_{OUT} = 1\text{ mA}$, $C_{IN} = 1\text{ }\mu\text{F}$, $C_{OUT} = 1\text{ }\mu\text{F}$, $-40^{\circ}\text{C} \leq T_J \leq +125^{\circ}\text{C}$, unless otherwise noted.

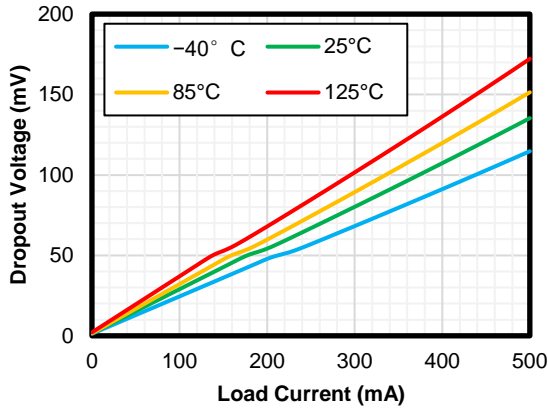

Figure 7 Dropout Voltage vs Output Current

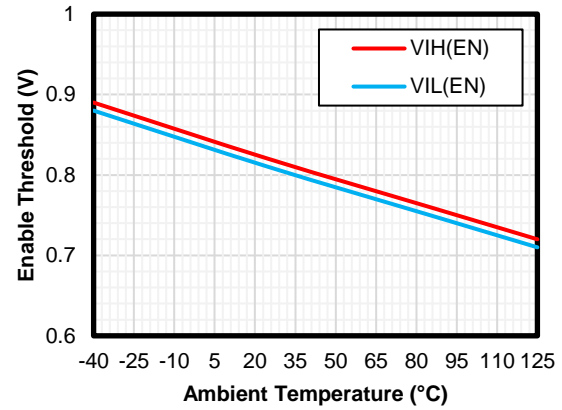

Figure 8 Enable Threshold vs. Temperature

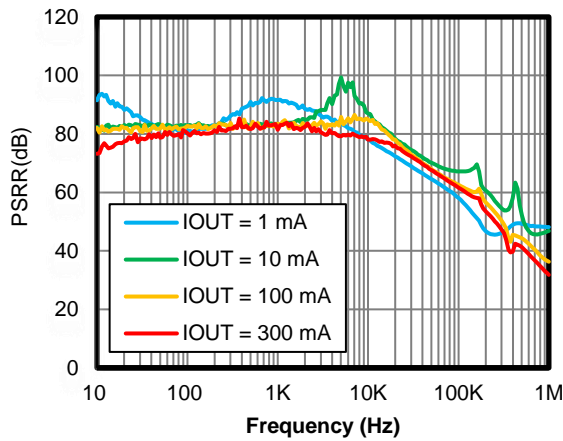

Figure 9 PSRR

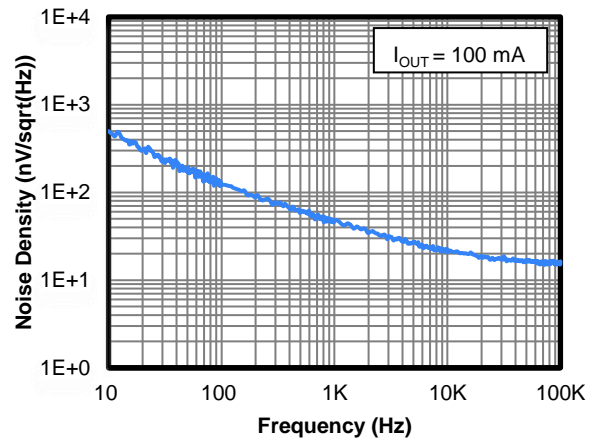

Figure 10 Noise

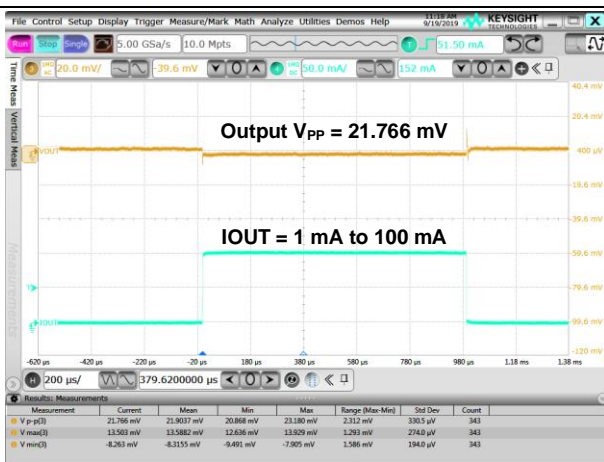

Figure 11 Load Transient

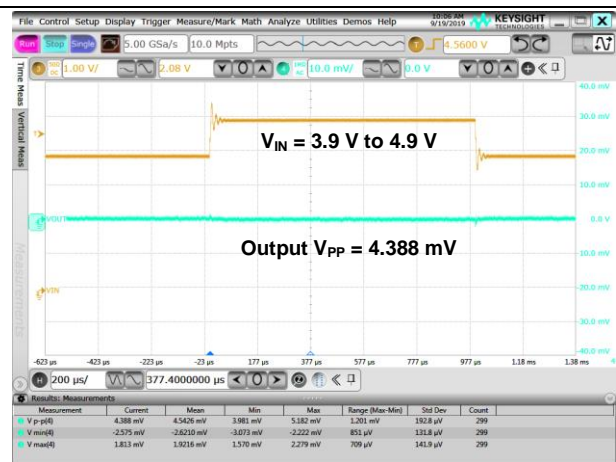

Figure 12 Line Transient

Detailed Description

Overview

The TPL9052 series products are 500-mA high PSRR, ultra-low noise, low dropout linear regulators with high output accuracy. The TPL9052 series products support both fixed output voltage ranges from 0.9 V to 5 V is stable with 1 μ F or larger ceramic output capacitor.

The TPL9052 series products have high PSRR with 88 dB at 10 kHz and 8.6 μ V_{RMS} ultra-low noise. These features make TPL9052 series products very suitable for noise-sensitive applications with high noise from previous stage power supply, such as high-performance analog devices, or high-definition imaging equipment.

The TPL9052 series products integrate protection features: output reverse current protection, output shortage protection, over-temperature protection and overload protection. All these features significantly improve the system reliability and simplify circuitry design under different operating conditions.

Functional Block Diagram

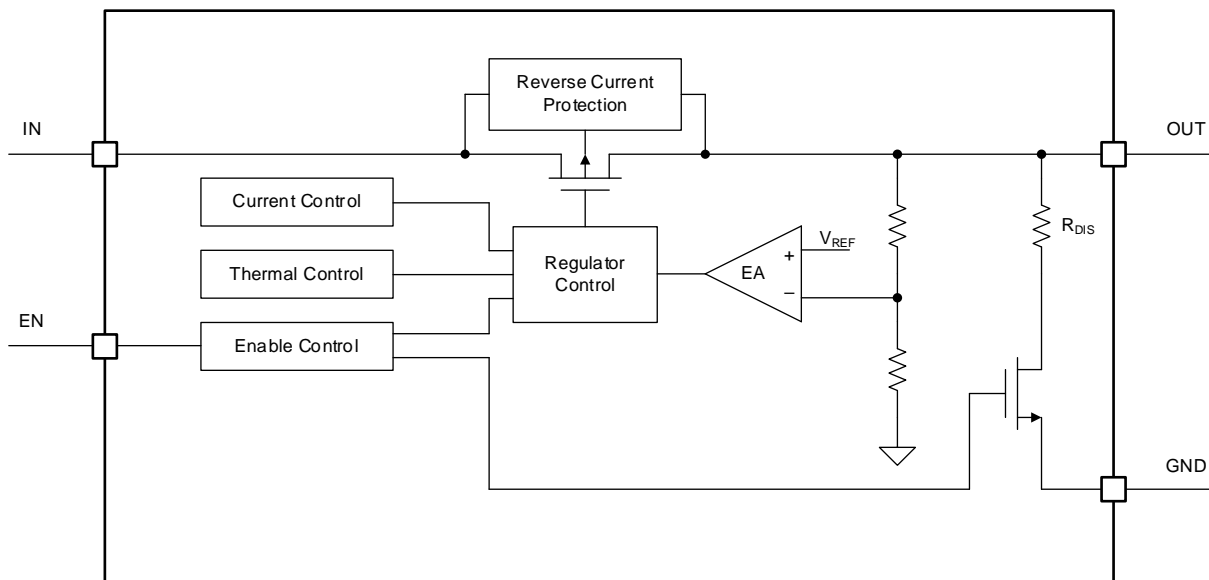

Figure 13 Functional Block Diagram

Feature Description

Enable (EN)

The enable pin (EN) is active high. Connect this pin to the GPIO of an external processor or digital logic control circuit to enable and disable the device. Or connect this pin to the IN pin for self-bias applications.

Operating Voltage Range (V_{IN})

The TPL9052 series do not include any dedicated UVLO circuitry. The output voltage of the TPL9052 series is not well regulated until V_{IN} exceeds 1.75 V or ($V_{OUT} + V_{DO}$), whichever is greater.

Regulated Output Voltage (V_{OUT})

The TPL9052 series are available in fixed voltage versions of 0.9 V to 5 V. When the input voltage is higher than $V_{OUT(NOM)} + 1$, output pin is the regulated output based on the selected voltage version. When the input voltage falls below $V_{OUT(NOM)} + 1$, output pin tracks the input voltage minus the dropout voltage based on the load current.

Reverse-Current Protection (RCP)

The TPL9052 series provide the reverse-current protection (RCP) to prevent output reverse current. If large capacitors are used at the output, there would be large reverse current when the input voltage is lower than output voltage. The TPL9052 series can shut off the regulator and body diode path to prevent the device damaged from reverse current fault.

Current Limit

The TPL9052 series integrate an internal current limit that helps to protect the regulator during fault conditions. When the output is shorted, the LDO supplies a typical current of 100 mA. Output voltage is not regulated when the device is in current limit, and $V_{OUT} = I_{CL} \times R_{LOAD}$.

Thermal Shutdown

During normal operation, LDO junction temperature should not exceed 125°C. When the junction temperature exceeds the thermal-shutdown threshold, the LDO shuts down the output immediately. Until when the junction temperature falls below the value of thermal-shutdown threshold minus thermal-shutdown hysteresis, the output turns on again.

Application and Implementation

NOTE

Information in the following applications sections is not part of the 3PEAK's component specification and 3PEAK does not warrant its accuracy or completeness. 3PEAK's customers are responsible for determining suitability of components for their purposes. Customers should validate and test their design implementation to confirm system functionality.

Application Information

The TPL9052 devices are a series of 500-mA high PSRR, ultra-low noise, low-dropout linear regulators. The following application schematic shows a typical usage of the TPL9052 series.

Typical Application

Figure 14 shows the typical application schematic of the TPL9052 series.

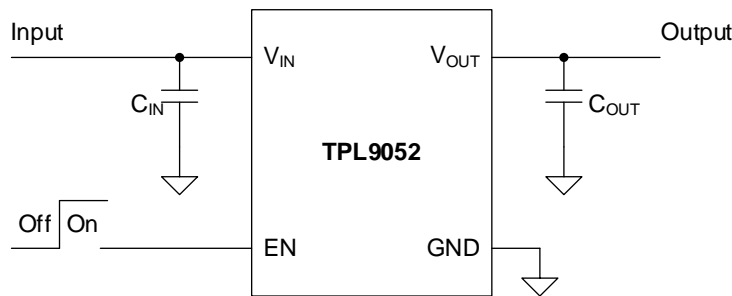

Figure 14 TPL9052 Typical Application Circuit

Input Capacitor and Output Capacitor

3PEAK recommends adding a 1 μF or greater capacitor with a 0.1 μF bypass capacitor in parallel at IN pin to keep the input voltage stable. The voltage rating of the capacitors must be greater than the maximum input voltage.

To ensure loop stability, the TPL9052 series require an output capacitor of 1 μF or greater. 3PEAK recommends selecting a X5R- or X7R-type ceramic capacitor with low ESR over temperature.

Both input capacitors and output capacitors must be placed as close to the device pins as possible.

Power Dissipation

During normal operation, LDO junction temperature should not exceed 125°C. Using below equations to calculate the power dissipation and estimate the junction temperature.

The power dissipation can be calculated using [Equation 1](#).

$$P_D = (V_{IN} - V_{OUT}) \times I_{OUT} + V_{IN} \times I_{GND} \quad (1)$$

The junction temperature can be estimated using [Equation 2](#). θ_{JA} is the junction-to-ambient thermal resistance.

$$T_J = T_A + P_D \times \theta_{JA} \quad (2)$$

Layout

Layout Guideline

- Both input capacitors and output capacitors must be placed as close to the device pins as possible.
- It is recommended to bypass the input pin to ground with a 0.1 μ F bypass capacitor. The loop area formed by the bypass capacitor connection, IN pin and the GND pin of the system must be as small as possible.
- It is recommended to use wide trace lengths or thick copper weight to minimize I×R drop and heat dissipation.

Tape and Reel Information

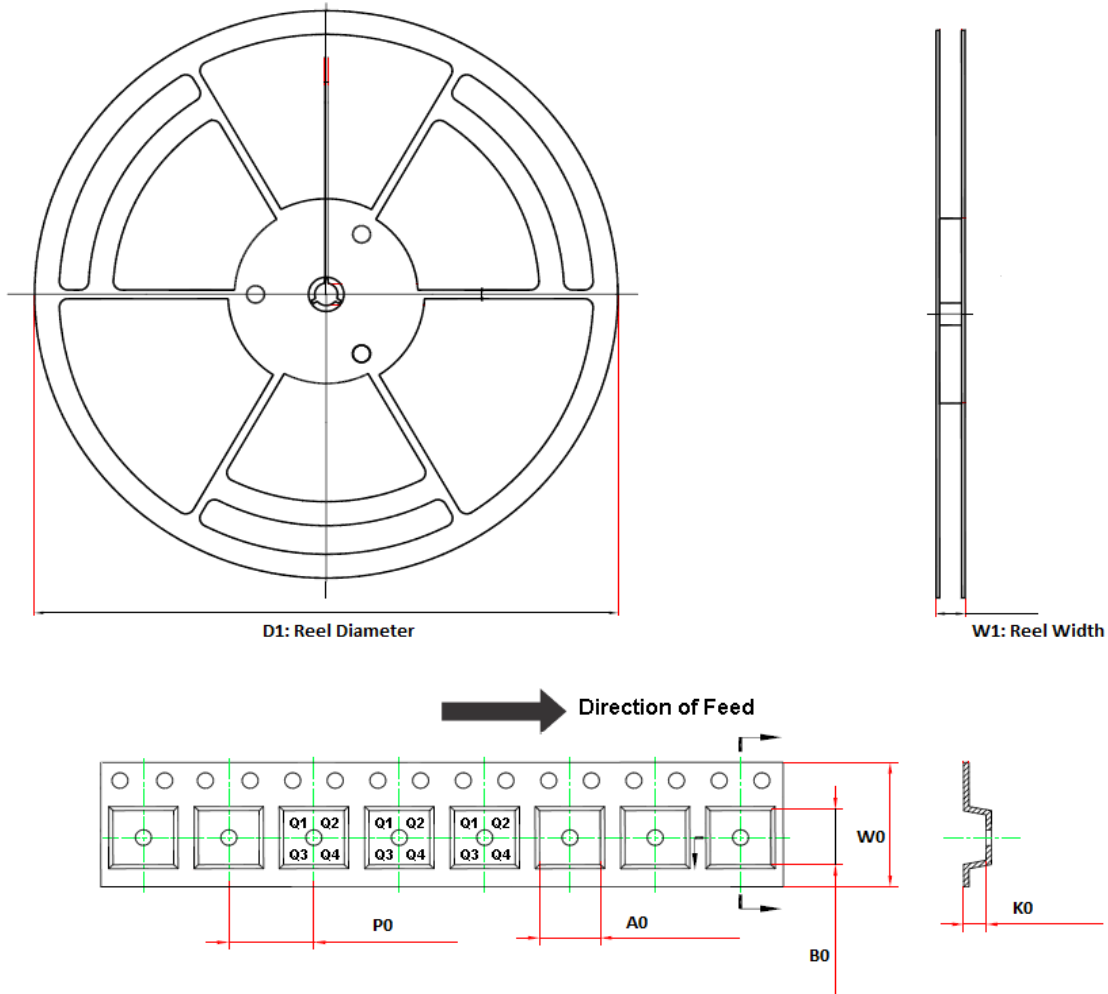

Order Number	Package	D1 (mm)	W1 (mm)	A0 (mm)	B0 (mm)	K0 (mm)	P0 (mm)	W0 (mm)	Pin1 Quadrant
TPL9052xx-S5TR ⁽¹⁾	SOT23-5	180.0	13.1	3.2	3.2	1.4	4.0	8.0	Q3
TPL9052xx-DF1R ⁽²⁾	DFN1X1-4	180.0	10.0	1.16	1.16	0.5	2.0	8.0	Q1
TPL905228-DF1R	DFN1X1-4	180.0	10.0	1.16	1.16	0.5	2.0	8.0	Q2
TPL905229-DF1R	DFN1X1-4	180.0	10.0	1.16	1.16	0.5	2.0	8.0	Q2

(1) Output voltage value, xx = 09 to 50. e.g., 33 means 3.3 V output voltage.

(2) Output voltage 2.8 V and 2.9 V are not included.

Package Outline Dimensions

SOT23-5

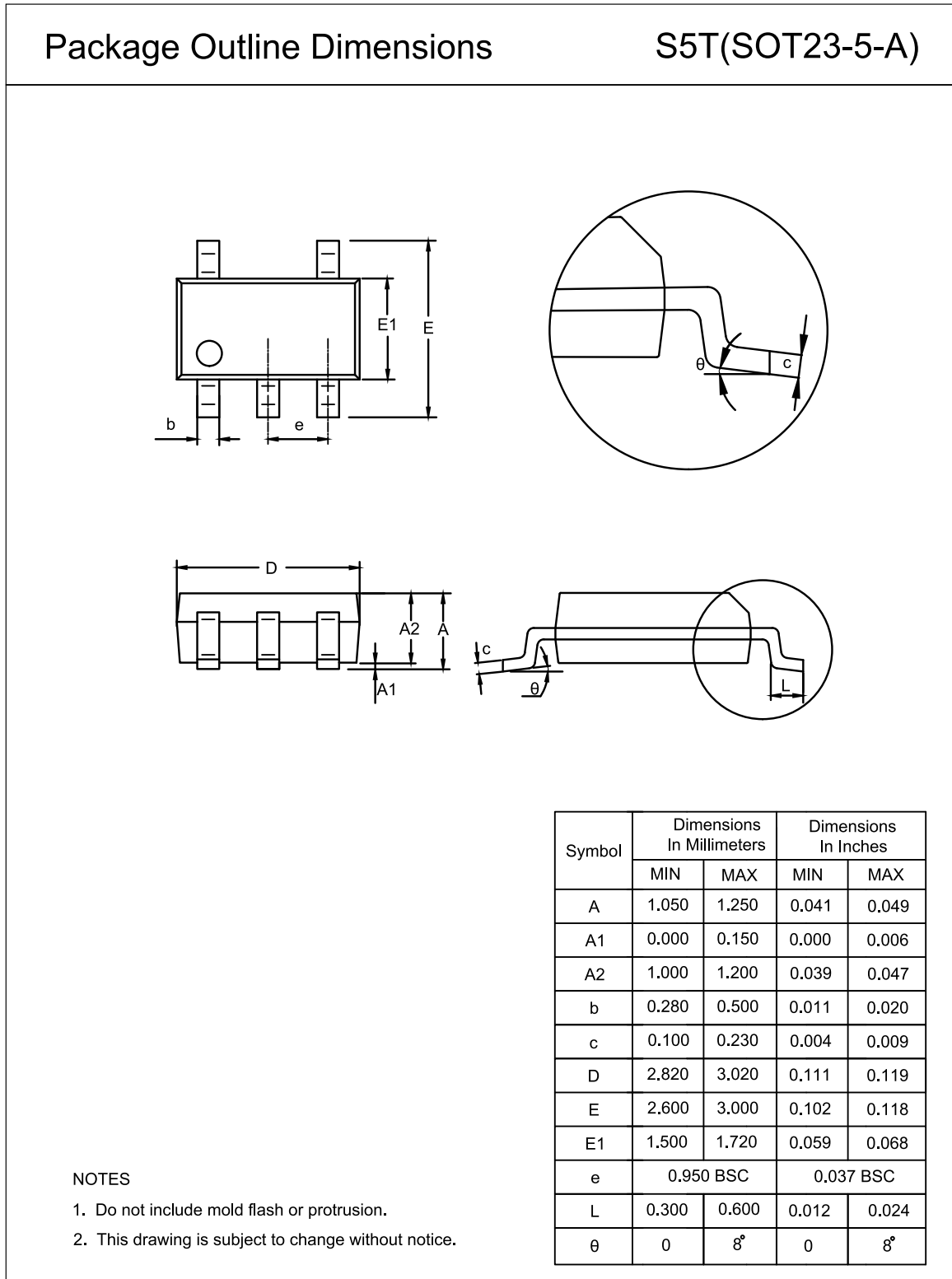

DFN1X1-4

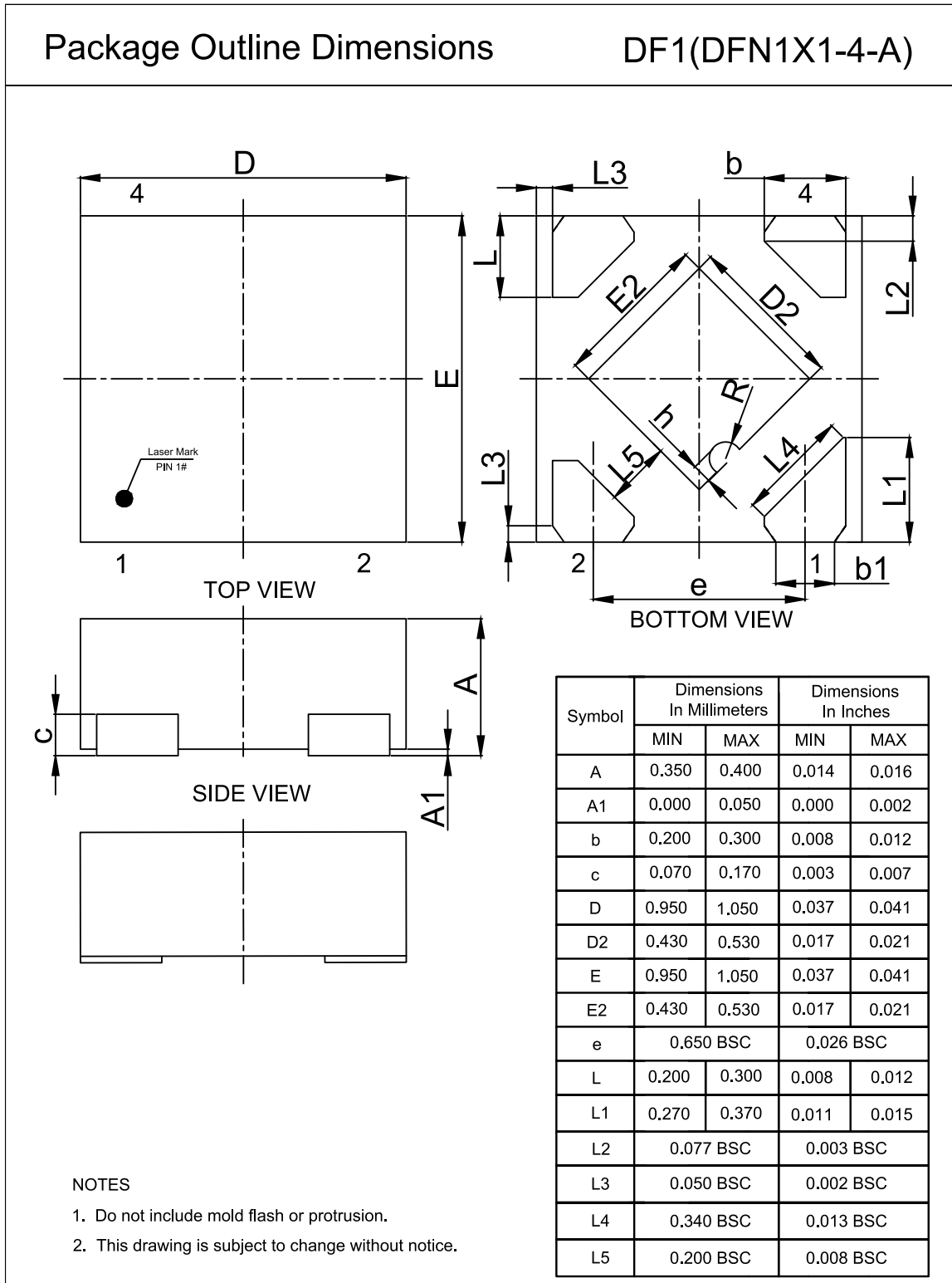

Order Information

Order Number	Operating Temperature Range	Package	Marking Information	MSL	Transport Media, Quantity	Eco Plan
TPL905209-S5TR ⁽¹⁾	-40°C to +125°C	SOT23-5	L8D	MSL3	Tape and Reel, 3,000	Green
TPL905210-S5TR ⁽¹⁾	-40°C to +125°C	SOT23-5	L8E	MSL3	Tape and Reel, 3,000	Green
TPL905211-S5TR ⁽¹⁾	-40°C to +125°C	SOT23-5	L8F	MSL3	Tape and Reel, 3,000	Green
TPL905212-S5TR	-40°C to +125°C	SOT23-5	L8G	MSL3	Tape and Reel, 3,000	Green
TPL905213-S5TR ⁽¹⁾	-40°C to +125°C	SOT23-5	L8H	MSL3	Tape and Reel, 3,000	Green
TPL905215-S5TR	-40°C to +125°C	SOT23-5	L8I	MSL3	Tape and Reel, 3,000	Green
TPL905216-S5TR ⁽¹⁾	-40°C to +125°C	SOT23-5	L8J	MSL3	Tape and Reel, 3,000	Green
TPL905218-S5TR	-40°C to +125°C	SOT23-5	L8K	MSL3	Tape and Reel, 3,000	Green
TPL905219-S5TR ⁽¹⁾	-40°C to +125°C	SOT23-5	L8L	MSL3	Tape and Reel, 3,000	Green
TPL905221-S5TR ⁽¹⁾	-40°C to +125°C	SOT23-5	L8M	MSL3	Tape and Reel, 3,000	Green
TPL905222-S5TR ⁽¹⁾	-40°C to +125°C	SOT23-5	L8N	MSL3	Tape and Reel, 3,000	Green
TPL905224-S5TR ⁽¹⁾	-40°C to +125°C	SOT23-5	L8O	MSL3	Tape and Reel, 3,000	Green
TPL905225-S5TR	-40°C to +125°C	SOT23-5	L8P	MSL3	Tape and Reel, 3,000	Green
TPL905226-S5TR ⁽¹⁾	-40°C to +125°C	SOT23-5	L8Q	MSL3	Tape and Reel, 3,000	Green
TPL905227-S5TR ⁽¹⁾	-40°C to +125°C	SOT23-5	L8R	MSL3	Tape and Reel, 3,000	Green
TPL905228-S5TR	-40°C to +125°C	SOT23-5	L8T	MSL3	Tape and Reel, 3,000	Green
TPL905229-S5TR	-40°C to +125°C	SOT23-5	L8V	MSL3	Tape and Reel, 3,000	Green
TPL905230-S5TR	-40°C to +125°C	SOT23-5	L8W	MSL3	Tape and Reel, 3,000	Green
TPL905231-S5TR ⁽¹⁾	-40°C to +125°C	SOT23-5	L8X	MSL3	Tape and Reel, 3,000	Green
TPL905232-S5TR ⁽¹⁾	-40°C to +125°C	SOT23-5	L8Y	MSL3	Tape and Reel, 3,000	Green
TPL905233-S5TR	-40°C to +125°C	SOT23-5	L8Z	MSL3	Tape and Reel, 3,000	Green
TPL905235-S5TR ⁽¹⁾	-40°C to +125°C	SOT23-5	L81	MSL3	Tape and Reel, 3,000	Green

Order Number	Operating Temperature Range	Package	Marking Information	MSL	Transport Media, Quantity	Eco Plan
TPL905236-S5TR	-40°C to +125°C	SOT23-5	L82	MSL3	Tape and Reel, 3,000	Green
TPL905237-S5TR ⁽¹⁾	-40°C to +125°C	SOT23-5	L83	MSL3	Tape and Reel, 3,000	Green
TPL905240-S5TR ⁽¹⁾	-40°C to +125°C	SOT23-5	L84	MSL3	Tape and Reel, 3,000	Green
TPL905245-S5TR	-40°C to +125°C	SOT23-5	L85	MSL3	Tape and Reel, 3,000	Green
TPL905250-S5TR ⁽¹⁾	-40°C to +125°C	SOT23-5	L86	MSL3	Tape and Reel, 3,000	Green
TPL905209-DF1R ⁽¹⁾	-40°C to +125°C	DFN1X1-4	L8D	MSL3	Tape and Reel, 3,000	Green
TPL905210-DF1R ⁽¹⁾	-40°C to +125°C	DFN1X1-4	L8E	MSL3	Tape and Reel, 3,000	Green
TPL905211-DF1R ⁽¹⁾	-40°C to +125°C	DFN1X1-4	L8F	MSL3	Tape and Reel, 3,000	Green
TPL905212-DF1R ⁽¹⁾	-40°C to +125°C	DFN1X1-4	L8G	MSL3	Tape and Reel, 3,000	Green
TPL905213-DF1R ⁽¹⁾	-40°C to +125°C	DFN1X1-4	L8H	MSL3	Tape and Reel, 3,000	Green
TPL905215-DF1R ⁽¹⁾	-40°C to +125°C	DFN1X1-4	L8I	MSL3	Tape and Reel, 3,000	Green
TPL905216-DF1R ⁽¹⁾	-40°C to +125°C	DFN1X1-4	L8J	MSL3	Tape and Reel, 3,000	Green
TPL905218-DF1R	-40°C to +125°C	DFN1X1-4	L8K	MSL3	Tape and Reel, 3,000	Green
TPL905219-DF1R ⁽¹⁾	-40°C to +125°C	DFN1X1-4	L8L	MSL3	Tape and Reel, 3,000	Green
TPL905221-DF1R ⁽¹⁾	-40°C to +125°C	DFN1X1-4	L8M	MSL3	Tape and Reel, 3,000	Green
TPL905222-DF1R ⁽¹⁾	-40°C to +125°C	DFN1X1-4	L8N	MSL3	Tape and Reel, 3,000	Green
TPL905224-DF1R ⁽¹⁾	-40°C to +125°C	DFN1X1-4	L8O	MSL3	Tape and Reel, 3,000	Green
TPL905225-DF1R	-40°C to +125°C	DFN1X1-4	L8P	MSL3	Tape and Reel, 3,000	Green
TPL905226-DF1R ⁽¹⁾	-40°C to +125°C	DFN1X1-4	L8Q	MSL3	Tape and Reel, 3,000	Green
TPL905227-DF1R ⁽¹⁾	-40°C to +125°C	DFN1X1-4	L8R	MSL3	Tape and Reel, 3,000	Green
TPL905228-DF1R ⁽¹⁾	-40°C to +125°C	DFN1X1-4	L8T	MSL3	Tape and Reel, 3,000	Green
TPL905229-DF1R	-40°C to +125°C	DFN1X1-4	L8V	MSL3	Tape and Reel, 3,000	Green
TPL905230-DF1R	-40°C to +125°C	DFN1X1-4	L8W	MSL3	Tape and Reel, 3,000	Green
TPL905231-DF1R	-40°C to +125°C	DFN1X1-4	L8X	MSL3	Tape and Reel, 3,000	Green

Order Number	Operating Temperature Range	Package	Marking Information	MSL	Transport Media, Quantity	Eco Plan
TPL905232-DF1R ⁽¹⁾	-40°C to +125°C	DFN1X1-4	L8Y	MSL3	Tape and Reel, 3,000	Green
TPL905233-DF1R	-40°C to +125°C	DFN1X1-4	L8Z	MSL3	Tape and Reel, 3,000	Green
TPL905235-DF1R ⁽¹⁾	-40°C to +125°C	DFN1X1-4	L81	MSL3	Tape and Reel, 3,000	Green
TPL905236-DF1R ⁽¹⁾	-40°C to +125°C	DFN1X1-4	L82	MSL3	Tape and Reel, 3,000	Green
TPL905237-DF1R ⁽¹⁾	-40°C to +125°C	DFN1X1-4	L83	MSL3	Tape and Reel, 3,000	Green
TPL905240-DF1R ⁽¹⁾	-40°C to +125°C	DFN1X1-4	L84	MSL3	Tape and Reel, 3,000	Green
TPL905245-DF1R ⁽¹⁾	-40°C to +125°C	DFN1X1-4	L85	MSL3	Tape and Reel, 3,000	Green
TPL905250-DF1R ⁽¹⁾	-40°C to +125°C	DFN1X1-4	L86	MSL3	Tape and Reel, 3,000	Green

(1) Future product, contact 3PEAK factory for more information and sample.

(2) Green: 3PEAK defines "Green" to mean RoHS compatible and free of halogen substances.

IMPORTANT NOTICE AND DISCLAIMER

Copyright© 3PEAK 2012-2023. All rights reserved.

Trademarks. Any of the 思瑞浦 or 3PEAK trade names, trademarks, graphic marks, and domain names contained in this document /material are the property of 3PEAK. You may NOT reproduce, modify, publish, transmit or distribute any Trademark without the prior written consent of 3PEAK.

Performance Information. Performance tests or performance range contained in this document/material are either results of design simulation or actual tests conducted under designated testing environment. Any variation in testing environment or simulation environment, including but not limited to testing method, testing process or testing temperature, may affect actual performance of the product.

Disclaimer. 3PEAK provides technical and reliability data (including data sheets), design resources (including reference designs), application or other design recommendations, networking tools, security information and other resources "As Is". 3PEAK makes no warranty as to the absence of defects, and makes no warranties of any kind, express or implied, including without limitation, implied warranties as to merchantability, fitness for a particular purpose or non-infringement of any third-party's intellectual property rights. Unless otherwise specified in writing, products supplied by 3PEAK are not designed to be used in any life-threatening scenarios, including critical medical applications, automotive safety-critical systems, aviation, aerospace, or any situations where failure could result in bodily harm, loss of life, or significant property damage. 3PEAK disclaims all liability for any such unauthorized use.