

## Features

- Fixed Output Voltage:
  - 1.25 V, 2.048 V, 2.5 V, 3 V, 3.3 V, 4.096 V
- High Initial Accuracy and Low Temperature Coefficient
  - Max 0.2%
  - 30 ppm/°C at -40°C to 85°C
  - 50 ppm/°C at -40°C to 125°C
- Operation From -40°C to 125°C
- Low Output Noise: 50  $\mu$ Vpp of TPR3525
- Quiescent current: 210  $\mu$ A
- Stable with 0.1 to 10  $\mu$ F Capacitive Loads

## Applications

- Power
- Instrumentation
- Industry

## Pin Configuration

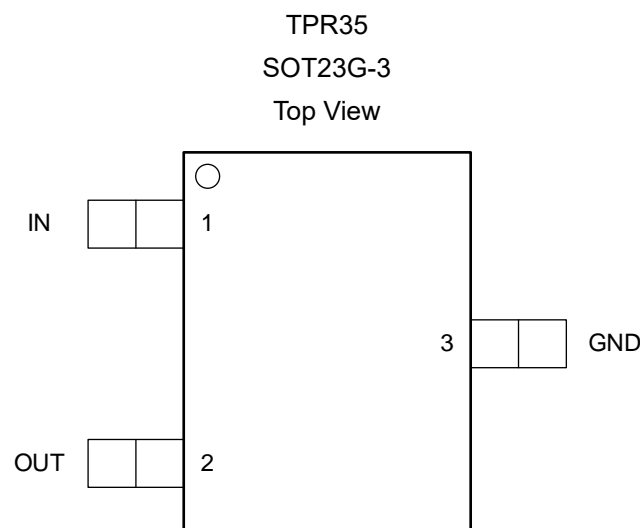

## Description

The TPR35 is a voltage reference with guaranteed temperature stability over the entire operating temperature range. The temperature range is extended from -40 °C to +125 °C.

**Product Family Table**

Order Number	Output Voltage (V)	Package
TPR3512-S3TR	1.25	SOT23G-3
TPR3520-S3TR	2.048	SOT23G-3
TPR3525-S3TR	2.5	SOT23G-3
TPR3530-S3TR	3	SOT23G-3
TPR3533-S3TR	3.3	SOT23G-3
TPR3540-S3TR	4.096	SOT23G-3

## Table of Contents

<b>Features</b> .....	1
<b>Applications</b> .....	1
<b>Description</b> .....	1
<b>Pin Configuration</b> .....	1
<b>Product Family Table</b> .....	2
<b>Revision History</b> .....	4
<b>Specifications</b> .....	5
Absolute Maximum Ratings <sup>(1)</sup> .....	5
ESD, Electrostatic Discharge Protection .....	5
Recommended Operating Conditions .....	5
Thermal Information .....	5
Electrical Characteristics .....	6
Typical Performance Characteristics – TPR3525 .....	8
<b>Tape and Reel Information</b> .....	11
<b>Package Outline Dimensions</b> .....	12
SOT23G-3 .....	12
<b>Order Information</b> .....	13
<b>IMPORTANT NOTICE AND DISCLAIMER</b> .....	14

## Revision History

Date	Revision	Notes
2020-9-10	Rev.A.0	Initial Version.
2021-11-24	Rev.A.1	1. Updated ESD Rating 2. Added Tape and Reel Information
2022-05-31	Rev.A.2	1. Added Recommended Operating Conditions 2. Added item of ISC, Short-circuit current, in Electrical Characteristics 3. Added typical value of Long-term stability 4. Corrected test conditions in the Electrical Characteristics table
2022-07-22	Rev.A.3	1. Corrected the information in Feature 2. Added figures in the Typical Performance Characteristics table

## Specifications

### Absolute Maximum Ratings <sup>(1)</sup>

Parameter		Min	Max	Unit
V <sub>IN</sub>	Supply Voltage	-0.3	6.9	V
T <sub>J</sub>	Junction Temperature Range	-40	150	°C
T <sub>A</sub>	Operating Temperature Range	-40	125	°C
T <sub>STG</sub>	Storage Temperature Range	-65	150	°C
T <sub>L</sub>	Lead Temperature (Soldering 10 sec)		260	°C

(1) Stresses beyond those listed under Absolute Maximum Ratings may cause permanent damage to the device. Exposure to any Absolute Maximum Rating condition for extended periods may affect device reliability and lifetime.

### ESD, Electrostatic Discharge Protection

Symbol	Parameter	Condition	Minimum Level	Unit
HBM	Human Body Model ESD	ANSI/ESDA/JEDEC JS-001 <sup>(1)</sup>	±4	kV
CDM	Charged Device Model ESD	ANSI/ESDA/JEDEC JS-002 <sup>(2)</sup>	±1.5	kV

(1) JEDEC document JEP155 states that 500-V HBM allows safe manufacturing with a standard ESD control process.

(2) JEDEC document JEP157 states that 250-V CDM allows safe manufacturing with a standard ESD control process.

### Recommended Operating Conditions

Parameter		Min	Max	Unit
V <sub>IN</sub>	Supply Voltage	2.1	5.5	V
I <sub>OUT</sub>	Output Current	-20	20	mA
T <sub>J</sub>	Junction Temperature Range	-40	125	°C

### Thermal Information

Package Type	θ <sub>JA</sub>	θ <sub>JC</sub>	Unit
SOT23G-3	250	81	°C/W
QFN 1.5X1.5-8	80	40	°C/W

**Electrical Characteristics**

 All test conditions:  $V_{IN} = 5\text{ V}$ ,  $T_A = +25^\circ\text{C}$ , unless otherwise noted.

Symbol	Parameter	Conditions	Min	Typ	Max	Unit
<b>TPR3512</b>						
$V_{OUT}$	Output Voltage			1.25		V
	Initial Accuracy		-0.2		0.2	%
	Output Voltage Noise	f = 0.1 Hz to 10 Hz		25		$\mu\text{Vpp}$
<b>TPR3520</b>						
$V_{OUT}$	Output Voltage			2.048		V
	Initial Accuracy		-0.2		0.2	%
	Output Voltage Noise	f = 0.1 Hz to 10 Hz		40		$\mu\text{Vpp}$
<b>TPR3525</b>						
$V_{OUT}$	Output Voltage			2.5		V
	Initial Accuracy		-0.2		0.2	%
	Output Voltage Noise	f = 0.1 Hz to 10 Hz		50		$\mu\text{Vpp}$
<b>TPR3530</b>						
$V_{OUT}$	Output Voltage			3.0		V
	Initial Accuracy		-0.2		0.2	%
	Output Voltage Noise	f = 0.1 Hz to 10 Hz		60		$\mu\text{Vpp}$
<b>TPR3533</b>						
$V_{OUT}$	Output Voltage			3.3		V
	Initial Accuracy		-0.2		0.2	%
	Output Voltage Noise	f = 0.1 Hz to 10 Hz		66		$\mu\text{Vpp}$
<b>TPR3540</b>						
$V_{OUT}$	Output Voltage			4.096		V
	Initial Accuracy		-0.2		0.2	%
	Output Voltage Noise	f = 0.1 Hz to 10 Hz		80		$\mu\text{Vpp}$

**Electrical Characteristics (Continued)**

 All test conditions:  $V_{IN} = 5\text{ V}$ ,  $T_A = +25^\circ\text{C}$ , unless otherwise noted.

Symbol	Parameter	Conditions	Min	Typ	Max	Unit	
<b>TPR3512, TPR3520, TPR3525, TPR3530, TPR3533, TPR3540, Power Supply</b>							
$V_{IN}$	Supply Voltage	TPR3512	2.1		5.5	V	
		All parts except TPR3512, $I_{LOAD} = \pm 1\text{ mA}$	$V_{OUT} + 0.05$		5.5	V	
$I_q$	Quiescent Current			150	210	$\mu\text{A}$	
		$T_A = -40\text{ to }125^\circ\text{C}$			250	$\mu\text{A}$	
	Minimum Dropout Voltage	$I_{LOAD} = \pm 1\text{ mA}$ , all parts except TPR3512	$T_A = 25^\circ\text{C}$		25	50	mV
			$T_A = 0\text{ to }70^\circ\text{C}$			50	mV
			$T_A = -40\text{ to }125^\circ\text{C}$			100	mV
		$I_{LOAD} = \pm 5\text{ mA}$ , all parts except TPR3512	$T_A = 25^\circ\text{C}$			200	mV
			$T_A = -40\text{ to }125^\circ\text{C}$			250	mV
<b>TPR3512, TPR3520, TPR3525, TPR3530, TPR3533, TPR3540, Reference Output</b>							
	Output Voltage Temperature Drift	$T_A = -40\text{ to }85^\circ\text{C}$		10	30	ppm/ $^\circ\text{C}$	
		$T_A = -40\text{ to }125^\circ\text{C}$		20	50		
	Line Regulation, TPR3512	$V_{IN} = 2.1\text{ to }5.5\text{ V}^{(1)}$	-65		65	ppm/V	
		$V_{IN} = 2.1\text{ to }5.5\text{ V}^{(1)}$ , $T_A = -40\text{ to }125^\circ\text{C}$	-85		85	ppm/V	
	Line Regulation, TPR35XX except for TPR3512	$V_{IN} = V_{OUT} + 300\text{ mV}$ to 5.5 V		-50		50	ppm/V
			$T_A = -40\text{ to }125^\circ\text{C}$	-70		70	ppm/V
	Load Regulation	$V_{IN} = V_{OUT} + 300\text{ mV}$ , $I_{LOAD} = -5\text{ to }5\text{ mA}^{(1)}$		-20	20	ppm/mA	
			$T_A = -40\text{ to }125^\circ\text{C}$	-30		30	ppm/mA
	Long Term Stability	0 to 1000 hours, $T_A = 25^\circ\text{C}$		200		ppm	
		1000 to 2000 hours, $T_A = 25^\circ\text{C}$		200		ppm	
	Thermal Hysteresis			80		ppm	
$I_{SC}$	Short-circuit Current	Sourcing and sinking		50		mA	
	Capacitive Load		0.1		10	$\mu\text{F}$	
	Turn-on Settling Time	To 0.1% with $C_L = 1\ \mu\text{F}$		500		$\mu\text{s}$	

(1) The minimum supply voltage for the TPR3512 is 2.1 V.

Typical Performance Characteristics – TPR3525

All test conditions:  $T_A = +25^\circ\text{C}$ , unless otherwise noted.

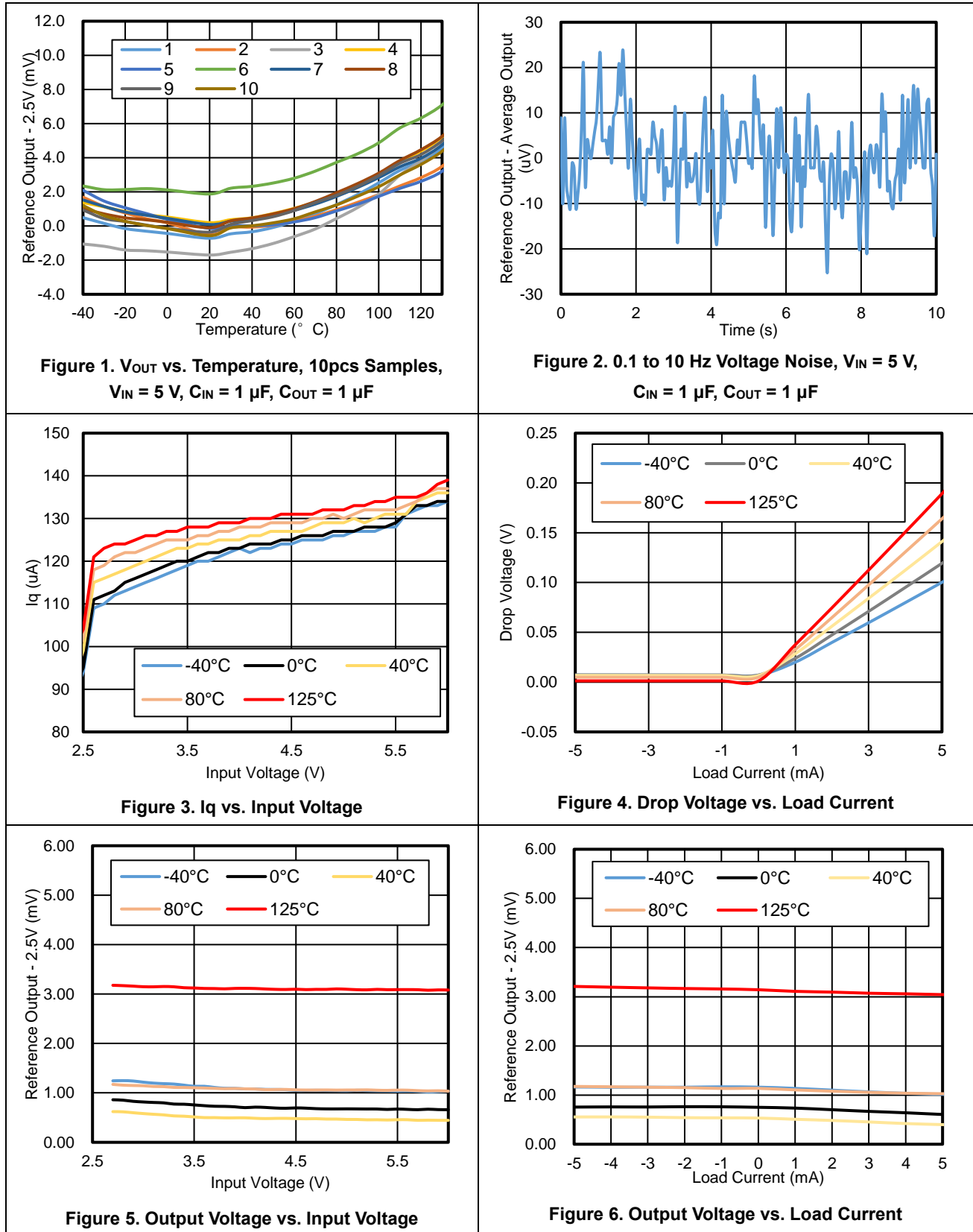



### Typical Performance Characteristics – TPR3525 (Continued)

All test conditions:  $T_A = +25^\circ\text{C}$ , unless otherwise noted.

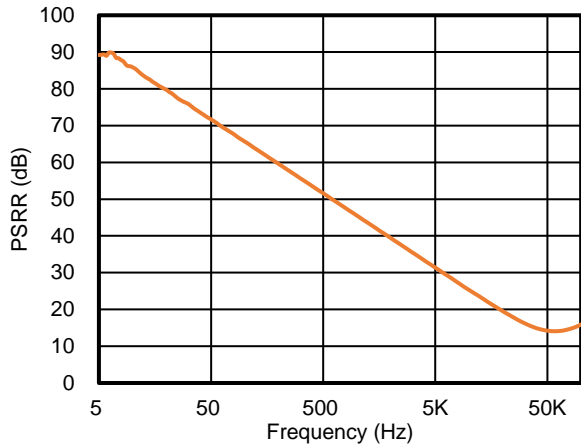

Figure 7. PSRR vs. Frequency

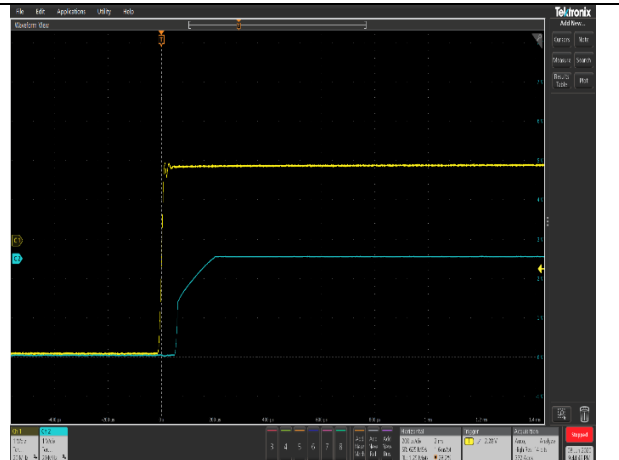

Figure 8. Step Response,  $V_{IN} = 5\text{ V}$ ,  $C_{IN} = 1\ \mu\text{F}$ ,  $C_{OUT} = 0.1\ \mu\text{F}$ ,  $200\ \mu\text{s/div}$

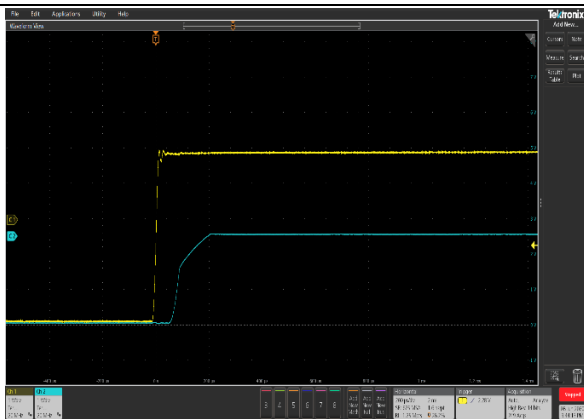

Figure 9. Step Response,  $V_{IN} = 5\text{ V}$ ,  $C_{IN} = 1\ \mu\text{F}$ ,  $C_{OUT} = 1\ \mu\text{F}$ ,  $200\ \mu\text{s/div}$

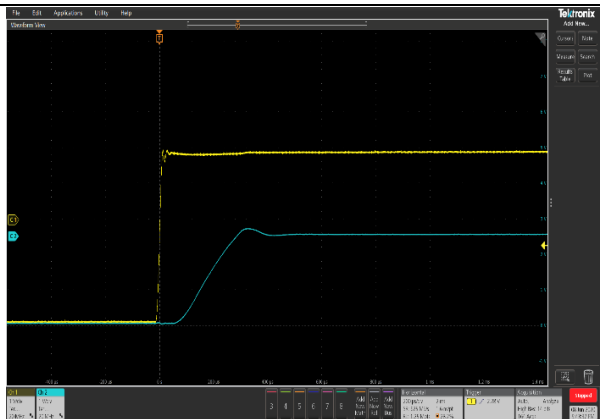

Figure 10. Step Response,  $V_{IN} = 5\text{ V}$ ,  $V_{IN} = 5\text{ V}$ ,  $C_{IN} = 1\ \mu\text{F}$ ,  $C_{OUT} = 10\ \mu\text{F}$ ,  $200\ \mu\text{s/div}$



Figure 11. Load Transient,  $\pm 5\text{ mA}$ ,  $V_{IN} = 5\text{ V}$ ,  $C_{IN} = 1\ \mu\text{F}$ ,  $C_{OUT} = 1\ \mu\text{F}$ ,  $50\text{ mV/div}$



Figure 12. Load Transient,  $\pm 5\text{ mA}$ ,  $V_{IN} = 2.8\text{ V}$ ,  $C_{IN} = 1\ \mu\text{F}$ ,  $C_{OUT} = 1\ \mu\text{F}$ ,  $50\text{ mV/div}$

### Typical Performance Characteristics – TPR3525 (Continued)

All test conditions:  $T_A = +25^\circ\text{C}$ , unless otherwise noted.



Figure 13. Load Transient,  $\pm 2\text{ mA}$ ,  $V_{IN} = 5\text{ V}$ ,  
 $C_{IN} = 1\ \mu\text{F}$ ,  $C_{OUT} = 1\ \mu\text{F}$ , 20 mV/div



Figure 14. Load Transient,  $\pm 2\text{ mA}$ ,  $V_{IN} = 2.8\text{ V}$ ,  
 $C_{IN} = 1\ \mu\text{F}$ ,  $C_{OUT} = 1\ \mu\text{F}$ , 20 mV/div

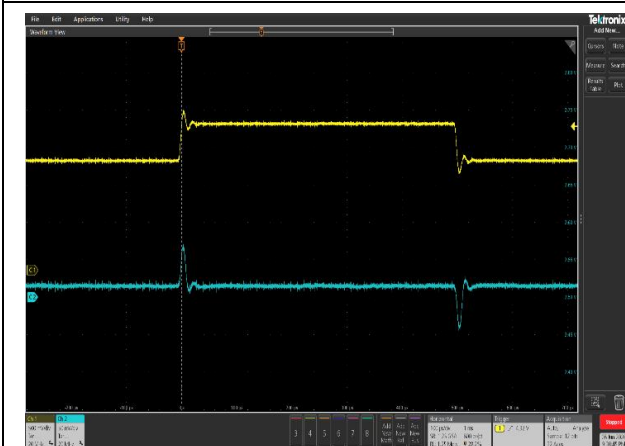

Figure 15. Line Transient, 500 mV Step,  
 $C_{IN} = 1\ \mu\text{F}$ ,  $C_{OUT} = 1\ \mu\text{F}$ , 50 mV/div

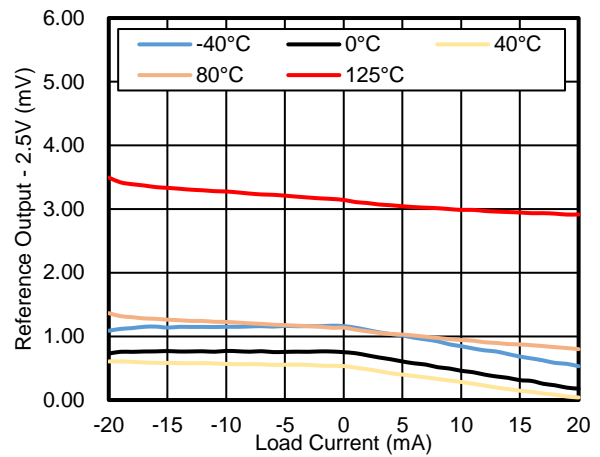
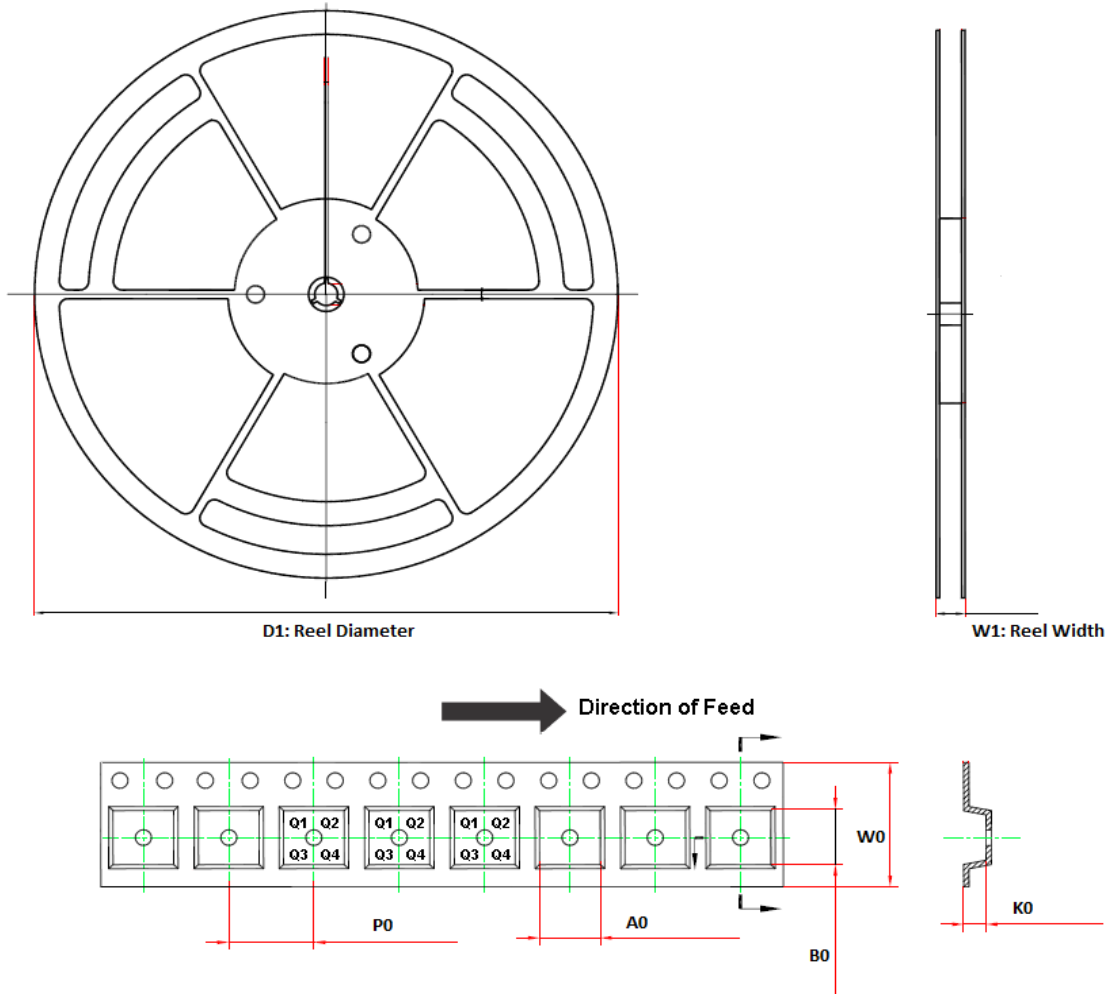

Figure 16. Output Voltage vs. Load Current

### Tape and Reel Information



Order Number	Package	D1 (mm)	W1 (mm)	A0 (mm)	B0 (mm)	K0 (mm)	P0 (mm)	W0 (mm)	Pin1 Quadrant
TPR35xx-S3TR	SOT23G-3	178	12.1	3.15	2.77	1.22	4.0	8.0	Q3

(1) Output voltage, xx = 12 to 40.

Package Outline Dimensions

SOT23G-3

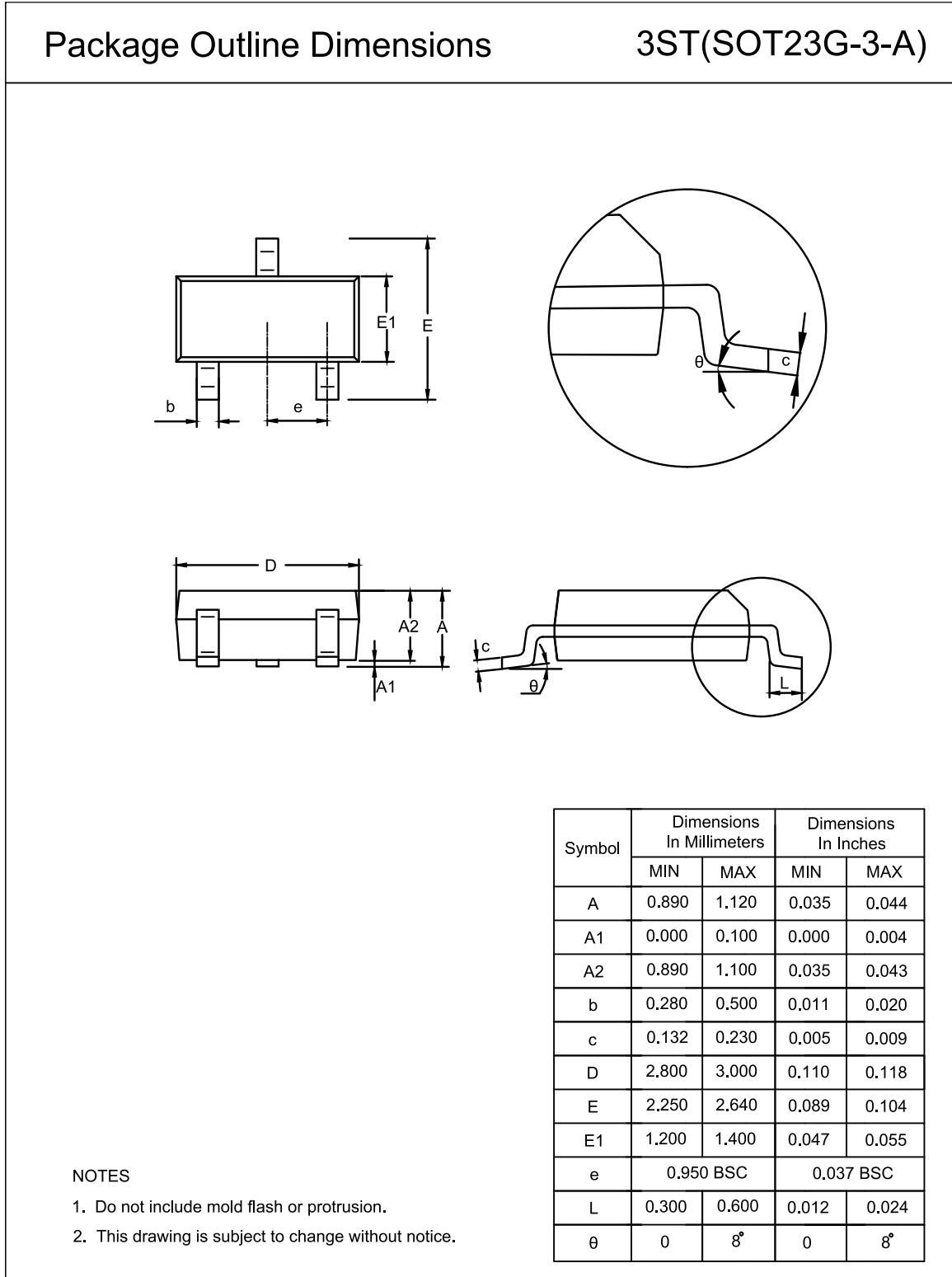

**Order Information**

Order Number	Operating Temperature Range	Package	Marking Information	MSL	Transport Media, Quantity	Eco Plan
TPR3512-S3TR	-40 to 125°C	SOT23G-3	R3A	MSL3	3,000	Green
TPR3520-S3TR	-40 to 125°C	SOT23G-3	R3B	MSL3	3,000	Green
TPR3525-S3TR	-40 to 125°C	SOT23G-3	R3C	MSL3	3,000	Green
TPR3530-S3TR	-40 to 125°C	SOT23G-3	R3D	MSL3	3,000	Green
TPR3533-S3TR	-40 to 125°C	SOT23G-3	R3E	MSL3	3,000	Green
TPR3540-S3TR	-40 to 125°C	SOT23G-3	R3F	MSL3	3,000	Green

(1) Green: 3PEAK defines "Green" to mean RoHS compatible and free of halogen substances.

## IMPORTANT NOTICE AND DISCLAIMER

**Copyright**© 3PEAK 2012-2023. All rights reserved.

**Trademarks.** Any of the 思瑞浦 or 3PEAK trade names, trademarks, graphic marks, and domain names contained in this document /material are the property of 3PEAK. You may NOT reproduce, modify, publish, transmit or distribute any Trademark without the prior written consent of 3PEAK.

**Performance Information.** Performance tests or performance range contained in this document/material are either results of design simulation or actual tests conducted under designated testing environment. Any variation in testing environment or simulation environment, including but not limited to testing method, testing process or testing temperature, may affect actual performance of the product.

**Disclaimer.** 3PEAK provides technical and reliability data (including data sheets), design resources (including reference designs), application or other design recommendations, networking tools, security information and other resources "As Is". 3PEAK makes no warranty as to the absence of defects, and makes no warranties of any kind, express or implied, including without limitation, implied warranties as to merchantability, fitness for a particular purpose or non-infringement of any third-party's intellectual property rights. Unless otherwise specified in writing, products supplied by 3PEAK are not designed to be used in any life-threatening scenarios, including critical medical applications, automotive safety-critical systems, aviation, aerospace, or any situations where failure could result in bodily harm, loss of life, or significant property damage. 3PEAK disclaims all liability for any such unauthorized use.